

FURUNO

OPERATOR'S MANUAL

REMOTE DISPLAY

Model

RD-50

ECF

(Elemental Chlorine Free)

The paper used in this manual
is elemental chlorine free.

FURUNO ELECTRIC CO., LTD.

9-52 Ashihara-cho,
Nishinomiya, 662-8580, JAPAN

• FURUNO Authorized Distributor/Dealer

All rights reserved. Printed in Japan

Pub. No. OME-44530-D3

(MISU) RD-50

A : JAN. 2010

D3 : AUG. 29, 2017



0 0 0 1 7 2 3 3 1 1 3

IMPORTANT NOTICES

General

- This manual has been authored with simplified grammar, to meet the needs of international users.
- The operator of this equipment must read and follow the descriptions in this manual. Wrong operation or maintenance can cancel the warranty or cause injury.
- Do not copy any part of this manual without written permission from FURUNO.
- If this manual is lost or worn, contact your dealer about replacement.
- The contents of this manual and equipment specifications can change without notice.
- The example screens (or illustrations) shown in this manual can be different from the screens you see on your display. The screens you see depend on your system configuration and equipment settings.
- Save this manual for future reference.
- Any modification of the equipment (including software) by persons not authorized by FURUNO will cancel the warranty.
- The following concern acts as our importer in Europe, as defined in DECISION No 768/2008/EC.
 - Name: FURUNO EUROPE B.V.
 - Address: Ridderhaven 19B, 2984 BT Ridderkerk, The Netherlands
- All brand and product names are trademarks, registered trademarks or service marks of their respective holders.

How to discard this product

Discard this product according to local regulations for the disposal of industrial waste. For disposal in the USA, see the homepage of the Electronics Industries Alliance (<http://www.eiae.org/>) for the correct method of disposal.

How to discard a used battery

Some FURUNO products have a battery(ies). To see if your product has a battery, see the chapter on Maintenance. Follow the instructions below if a battery is used. Tape the + and - terminals of battery before disposal to prevent fire, heat generation caused by short circuit.

In the European Union

The crossed-out trash can symbol indicates that all types of batteries must not be discarded in standard trash, or at a trash site. Take the used batteries to a battery collection site according to your national legislation and the Batteries Directive 2006/66/EU.



In the USA

The Mobius loop symbol (three chasing arrows) indicates that Ni-Cd and lead-acid rechargeable batteries must be recycled. Take the used batteries to a battery collection site according to local laws.

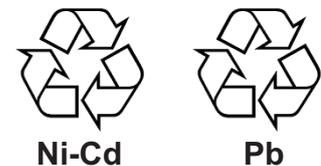

In the other countries

There are no international standards for the battery recycle symbol. The number of symbols can increase when the other countries make their own recycle symbols in the future.



SAFETY INSTRUCTIONS



WARNING

Indicates a condition that can cause death or serious injury if not avoided.



CAUTION

Indicates a condition that can cause minor or moderate injury if not avoided.

Safety Instructions for the Operator



WARNING



Do not disassemble or modify the equipment.

Fire, electrical shock or serious injury can occur.



Turn off the power immediately if water leaks into the equipment or smoke or fire is coming from the equipment.

Failure to turn off the equipment can cause fire or electrical shock. Contact a FURUNO agent for service.



Keep heater away from the equipment.

Heat can change the equipment shape and melt the power cord, which can cause fire or electrical shock.



Use the correct fuse.

A wrong fuse can damage the equipment and cause fire.

About the TFT LCD

The TFT LCD is constructed using the latest LCD techniques, and displays 99.99% of its pixels. The remaining 0.01% of the pixels may drop out or blink, however this is not an indication of malfunction.

Safety Instructions for the Installer



WARNING



Turn off the power at the switchboard before you install the equipment.

Fire or electrical shock can occur if the power is left on.



Be sure that the power supply is compatible with the voltage rating of the equipment.

Connection of an incorrect power supply can cause fire or equipment damage. The voltage rating of the equipment appears on the label above the power connector.



CAUTION



Ground the equipment to prevent mutual interference.

Observe the following compass safe distances to prevent interference to a magnetic compass:

Model	Standard compass	Steering compass
RD-50	0.45 m	0.30 m
RD-501	1.30 m	0.85 m
RD-502	1.00 m	0.65 m
RD-50 + DS-605	0.95 m	0.60 m

TABLE OF CONTENTS

FOREWORD	v
SYSTEM CONFIGURATION	vi
1. BASIC OPERATION	1-1
1.1 Controls.....	1-1
1.2 How to Turn On/Off the Power.....	1-3
1.3 How to Adjust Display Brilliance.....	1-5
1.4 Data Screen (not applicable for ROTI).....	1-6
2. MENU	2-1
2.1 Menu Description.....	2-1
2.2 How to Customize the Data Screen.....	2-2
2.3 How to Preset Scales/Indications.....	2-6
2.4 How to Set the Speed Graphic Range.....	2-8
2.5 Depth Graph.....	2-10
2.6 Water TEMP Graph.....	2-12
2.7 Rudder Graphic.....	2-14
2.7.1 How to set the range for rudder graphic and position for rudder.....	2-14
2.7.2 Rudder order symbol.....	2-16
2.8 Engine/Shaft Graphic.....	2-17
2.9 How to Show/Hide the Digital Indication.....	2-18
2.10 Units of Measurement.....	2-18
2.11 Direction Symbol.....	2-20
2.12 Symbol Location.....	2-21
2.13 System Menu.....	2-22
2.14 Time Setup.....	2-25
2.14.1 How to select the time source.....	2-25
2.14.2 How to set the summer time.....	2-26
2.15 Trip Distance.....	2-27
2.16 Operation with RD-501.....	2-28
3. MAINTENANCE, TROUBLESHOOTING	3-1
3.1 Maintenance.....	3-1
3.2 Life of the Parts.....	3-2
3.3 Diagnostic Test.....	3-3
3.4 LCD Test.....	3-4
3.5 How to Reset the User Settings.....	3-5
3.6 Simulation Mode.....	3-6
3.7 Parts Location and Parts List.....	3-7
4. INSTALLATION	4-1
4.1 Equipment List.....	4-1
4.2 Installation of Remote Display.....	4-1
4.3 Installation of Remote Controller and Dimmer Controller.....	4-4
4.4 Installation of Remote Display with DS-605 (Waterproof Box).....	4-5
4.5 Wiring.....	4-8
4.6 Adjustments.....	4-13
4.7 JIS Cable Guide.....	4-15
APPENDIX 1 MENU TREE	AP-1
APPENDIX 2 SCREEN DIVISION	AP-2

TABLE OF CONTENTS

APPENDIX 3 LIST OF TERMS	AP-3
APPENDIX 4 DIGITAL INTERFACE.....	AP-5
SPECIFICATIONS	SP-1
PACKING LISTS	A-1
OUTLINE DRAWINGS.....	D-1
INTERCONNECTION DIAGRAM	S-1
INDEX.....	IN-1

FOREWORD

A Word to the Owner of the RD-50 Remote Display

Congratulations on your choice of the FURUNO RD-50 Remote Display. We are confident you will see why the FURUNO name has become synonymous with quality and reliability.

Since 1948, FURUNO Electric Company has enjoyed an enviable reputation for innovative and dependable marine electronics equipment. This dedication to excellence is furthered by our extensive global network of agents and dealers.

Your equipment is designed and constructed to meet the rigorous demands of the marine environment. However, no machine can perform its intended function unless properly installed and maintained. Please carefully read and follow the operation and maintenance procedures set forth in this manual.

We would appreciate feedback from you, the end-user, about whether we are achieving our purposes.

Thank you for considering and purchasing FURUNO equipment.

Features

The RD-50 Remote Display can display the various navigation data by connection with the sensor signals. The main features of the RD-50 are as shown below.

- 8.4" color LCD is visible in direct sunlight.
- The size conforms to DIN (Deutsche Industrie Normen) standards, so there is uniformity among the remote displays of other makers.
- Display the navigation data in digital, graphic and analog formats.
- Screen division (up to four indications) is available.
- Daisy chain connection is available for connecting a total of ten RD-50s.
- When you connect multiple RD-50s, their display brilliances can be adjusted together.

Program Number

Program	Number	Initial Version
RD-50		
Starter	2651006-01.xx	Jan. 2010
Booter	2651007-01.xx	Jan. 2010
Main	2651008-01.xx	Jan. 2010
RD-501, RD-502		
	2651009-01.xx	Aug. 2009

xx: minor change

CE declaration

With regards to CE declarations, please refer to our website (www.furuno.com), for further information about RoHS conformity declarations.

SYSTEM CONFIGURATION

Single remote display

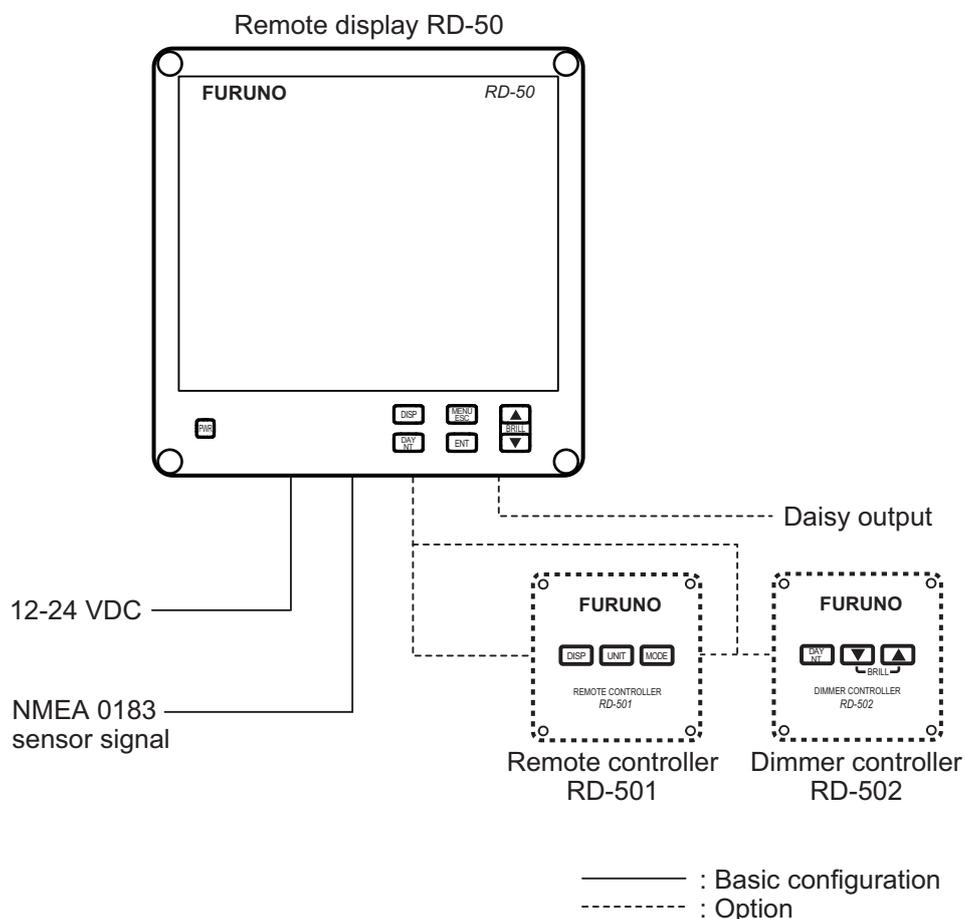

Environmental category

RD-50 RD-501 RD-502	Protected from weather
RD-50 + DS-605	Exposed to weather

Multiple remote displays (daisy chain connection)

Pattern 1: Sensor signal and dimmer controller are commonly used. A total of 10 remote display units can be connected.

a) RD-50 daisy chain

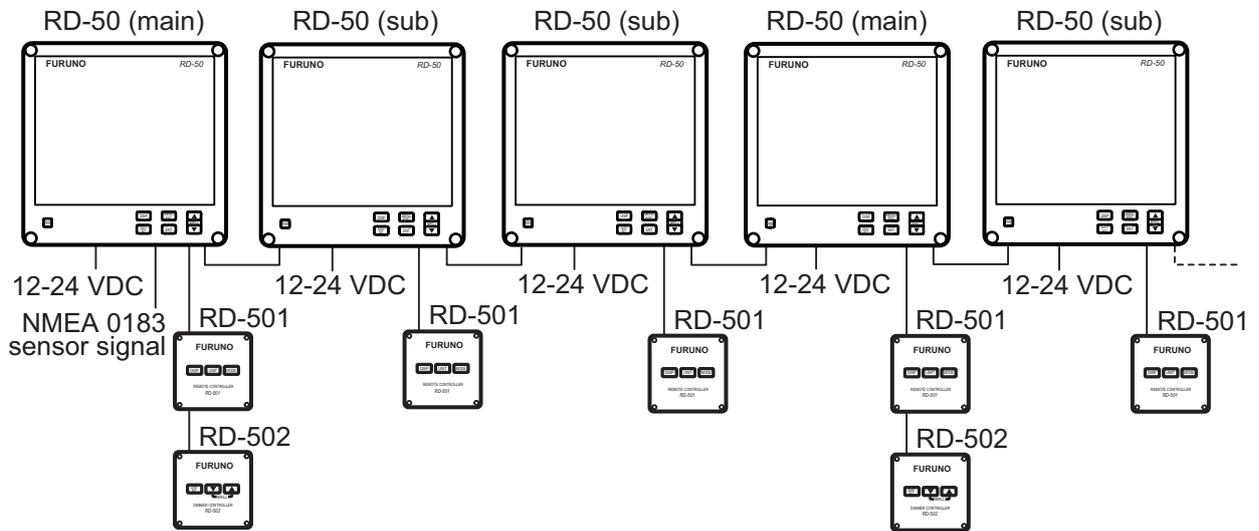

b) RD-50 and RD-20 combination daisy chain

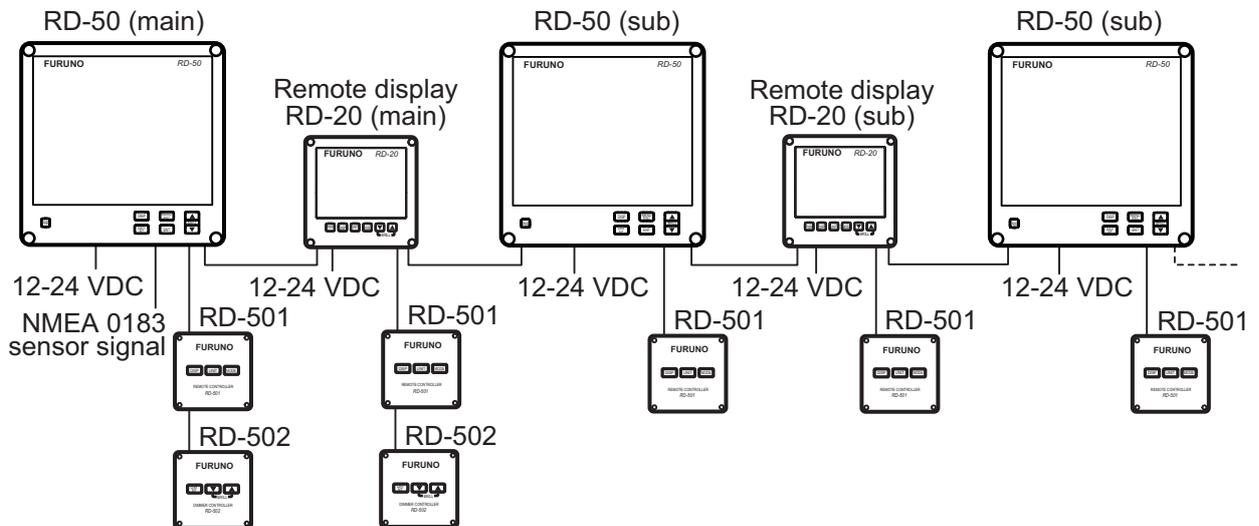

c) RD-50, RD-20 and DS-600 combination daisy chain

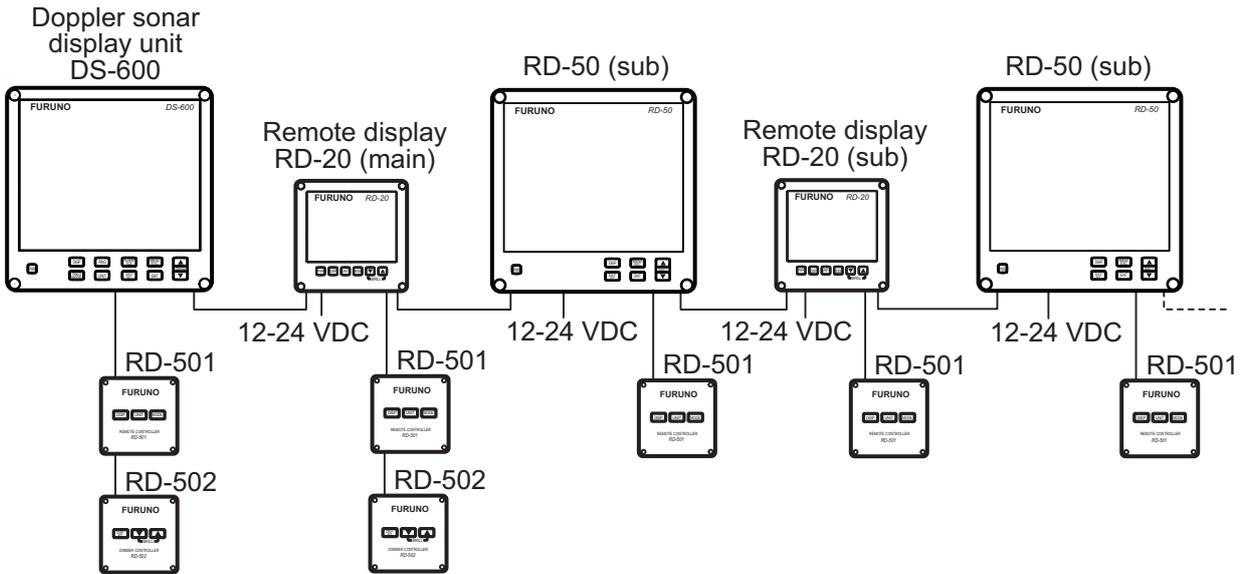

Pattern 2: Dimmer controller is commonly used. A total of 10 remote display (RD-50) units can be connected.

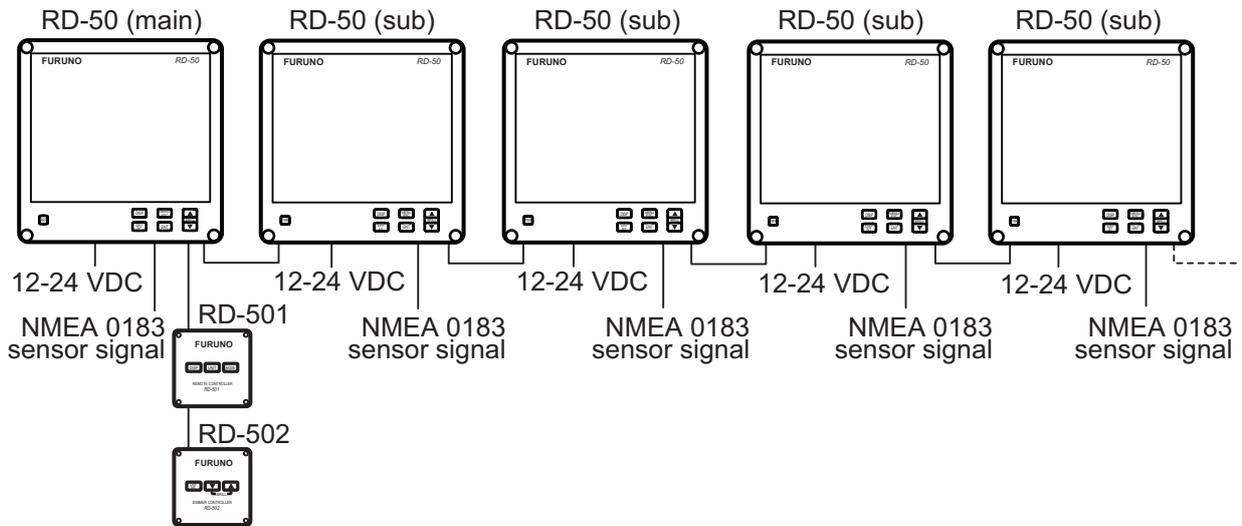

1. BASIC OPERATION

1.1 Controls

Remote display RD-50

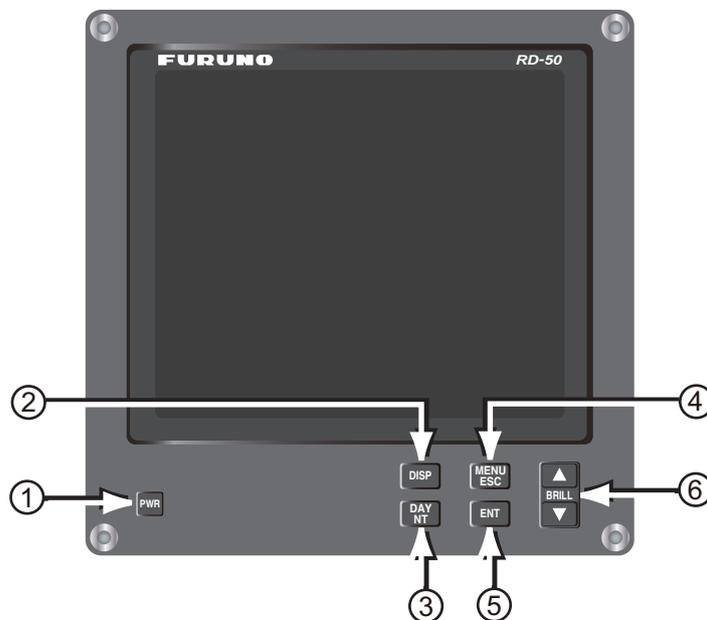

No.	Control	Description
1	PWR	Turn on/off the power.
2	DISP	<ul style="list-style-type: none"> Switch the screen. Return to the data screen during MENU display.
3	DAY/NT	Switch the display between daytime use and nighttime use on a "main" RD-50. When setting the RD-50 (sub), Daytime and Nighttime keys are not available. Daytime: Black characters on white background. Nighttime: White characters on black background.
4	MENU/ESC	<ul style="list-style-type: none"> Open/close the menu. Cancel last entry in menu operation and return one layer.
5	ENT	<ul style="list-style-type: none"> Go back one layer when you save the menu option in the undermost layer. Go up one layer when you save the menu option. Long press to reset the trip distance when the [Trip DIST] screen is displayed with [Internal] mode.
6	BRILL ▲, ▼	<ul style="list-style-type: none"> ▲: Increase the display brilliance. Move the cursor upward during MENU display. ▼: Decrease the display brilliance. Move the cursor downward during MENU display. <p>Note: Hold down ▲ or ▼ key to change the display brilliance rapidly.</p>

1. BASIC OPERATION

How to remove the hard cover

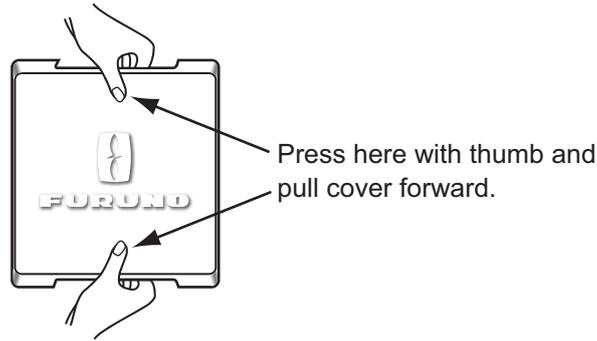

Remote controller RD-501

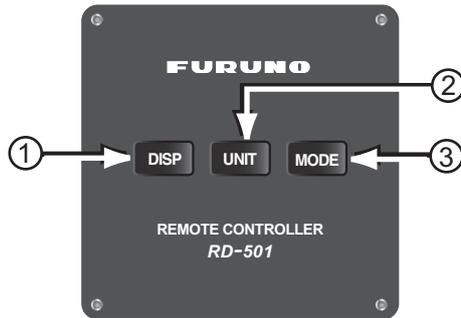

No.	Control	Description
1	DISP	<ul style="list-style-type: none"> • Switch the screen. • Return to the data screen during MENU display.
2	UNIT	Select the units of measurement (see section 2.10).
3	MODE	Select the scales/indications (see section 2.16).

Dimmer controller RD-502

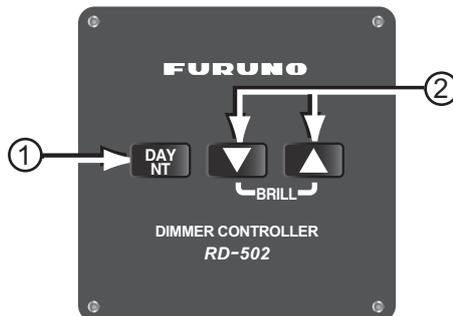

No.	Control	Description
1	DAY/NT	Switch the display between daytime use and nighttime use. Day-time: Black characters on white background. Nighttime: White characters on black background.
2	▼, ▲	<ul style="list-style-type: none"> ▼: Decrease the display brilliance. ▲: Increase the display brilliance.

1.2 How to Turn On/Off the Power

Turn on the power

Press the **PWR** key to turn on the power. The initialization screen appears followed by the start-up screen. The start-up screen shows the unit name, serial number, program number and the results of the ROM and RAM check, OK or NG (No Good). If NG appears, contact your dealer.



XX.XX: Program version number

Initialization screen

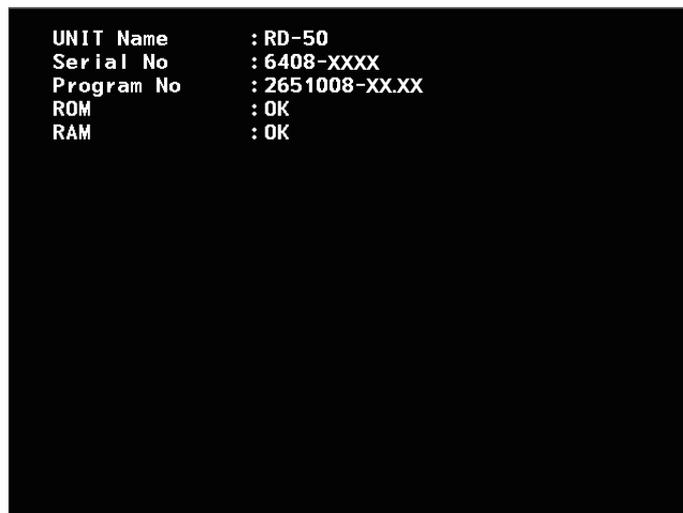

XXXX: Serial number

XX.XX: Program version number

Start-up screen

After the self-tests are completed, the last-used data screen (see section 1.4) appears.

Note 1: The screen refreshes slower in low temperature ambient.

Note 2: The view angle at nighttime is narrower than at daytime.

1. BASIC OPERATION

Turn off the power

Press the **PWR** key to turn off the power.

Note: When you turn off the power of a RD-50 in a daisy chain, the following RD-50s can not receive the sensor signals.

Case 1

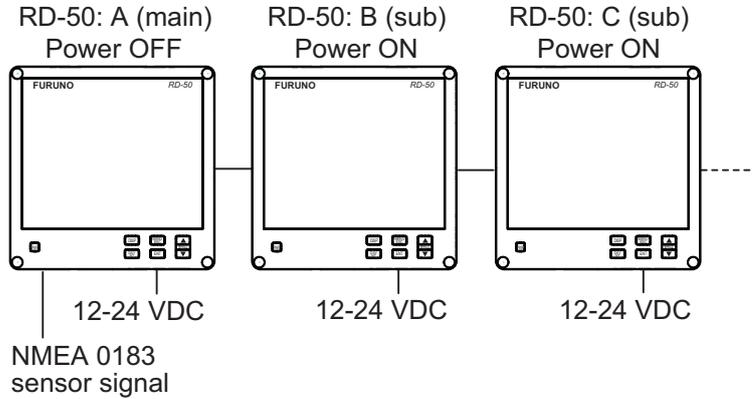

When you turn off the RD-50 A power, both RD-50 B and RD-50 C can not receive the sensor signal even though you turn on the power for RD-50 B and RD-50 C.

Case 2

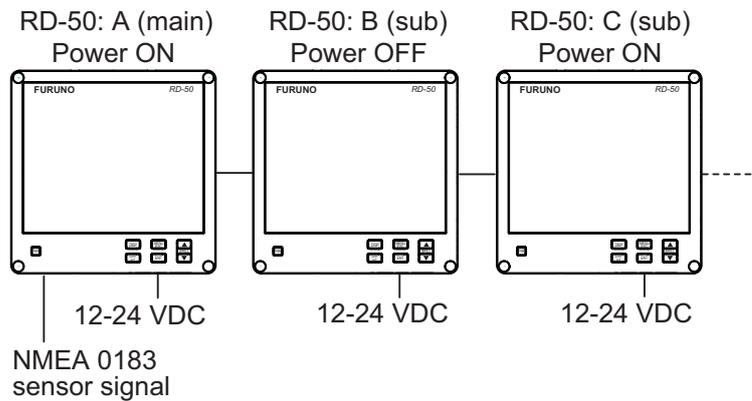

When you turn off the RD-50 B power, RD-50 C can not receive the sensor signal even though you turn on the power for RD-50 C.

Note: RD-50 (main) and RD-50 (sub) are set by the installer. See section 4.6.

1.3 How to Adjust Display Brilliance

To adjust the display brilliance, press ▼ or ▲ key. The setting range is 0 to 9. "0" is off and "9" is the brightest. Hold down ▼ or ▲ key to change the display brilliance rapidly.

Operation with RD-50 (main)

The RD-50 (main) simultaneously controls the display brilliance of the RD-50 (main) and the RD-50s (sub).

- Controls with ▼ key: Decrease the display brilliance.
- Controls with ▲ key: Increase the display brilliance.

Operation with RD-50 (sub)

Adjust the display brilliance of an RD-50 (sub) as follows to equalize brilliance with RD-50 (main). The variation is smaller than that of RD-50 (main) and RD-502 connected to RD-50 (main).

- Controls with ▼ key: Decrease the display brilliance.
- Controls with ▲ key: Increase the display brilliance.

Note 1: When setting RD-50 (sub), the variation becomes small.

Note 2: When the display brilliance is 0, 1 or 9 on a main RD-50, this operation by RD-50 (sub) is not available.

Operation with RD-502

The RD-502 simultaneously controls the display brilliance of the RD-50 (main) and the RD-50s (sub).

- Controls with ▼ key: Decrease the display brilliance.
- Controls with ▲ key: Increase the display brilliance.

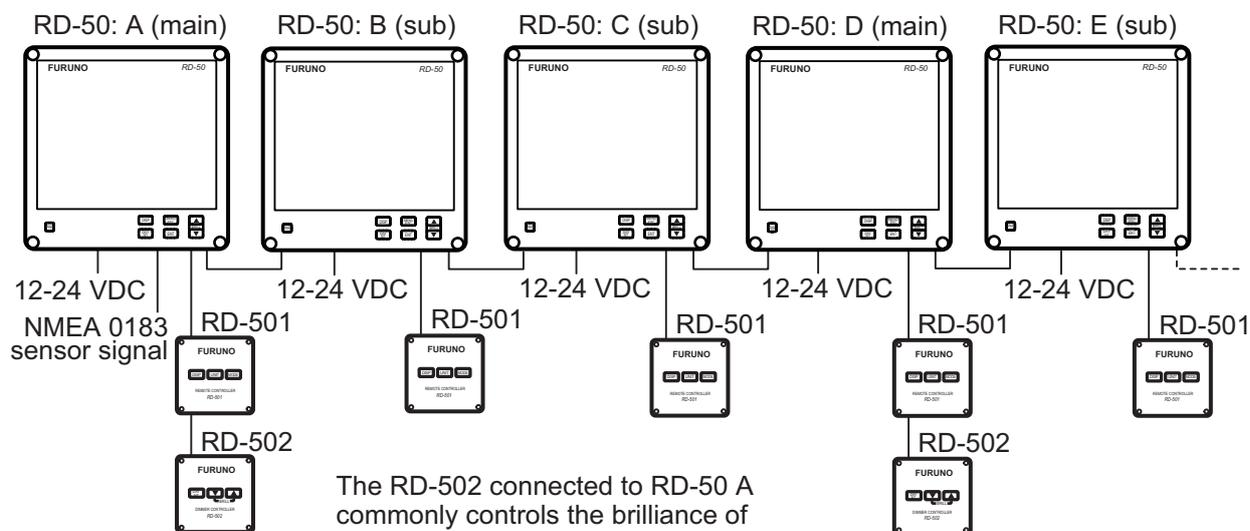

The RD-502 connected to RD-50 A commonly controls the brilliance of RD-50 A, RD-50 B and RD-50 C. The RD-502 connected to RD-50 D commonly controls the brilliance of RD-50 D and RD-50 E.

1.4 Data Screen (not applicable for ROTI)

You can switch up to five data screens with the **DISP** key (three data screens in default setting). When you press the **DISP** key, the data screen changes in the sequence of DISP1 → DISP2 → DISP3 → DISP4* → DISP5* → DISP1 → ... Unregistered screens are skipped when you press the **DISP** key. The default screens are as shown below. For details, see section 2.2.

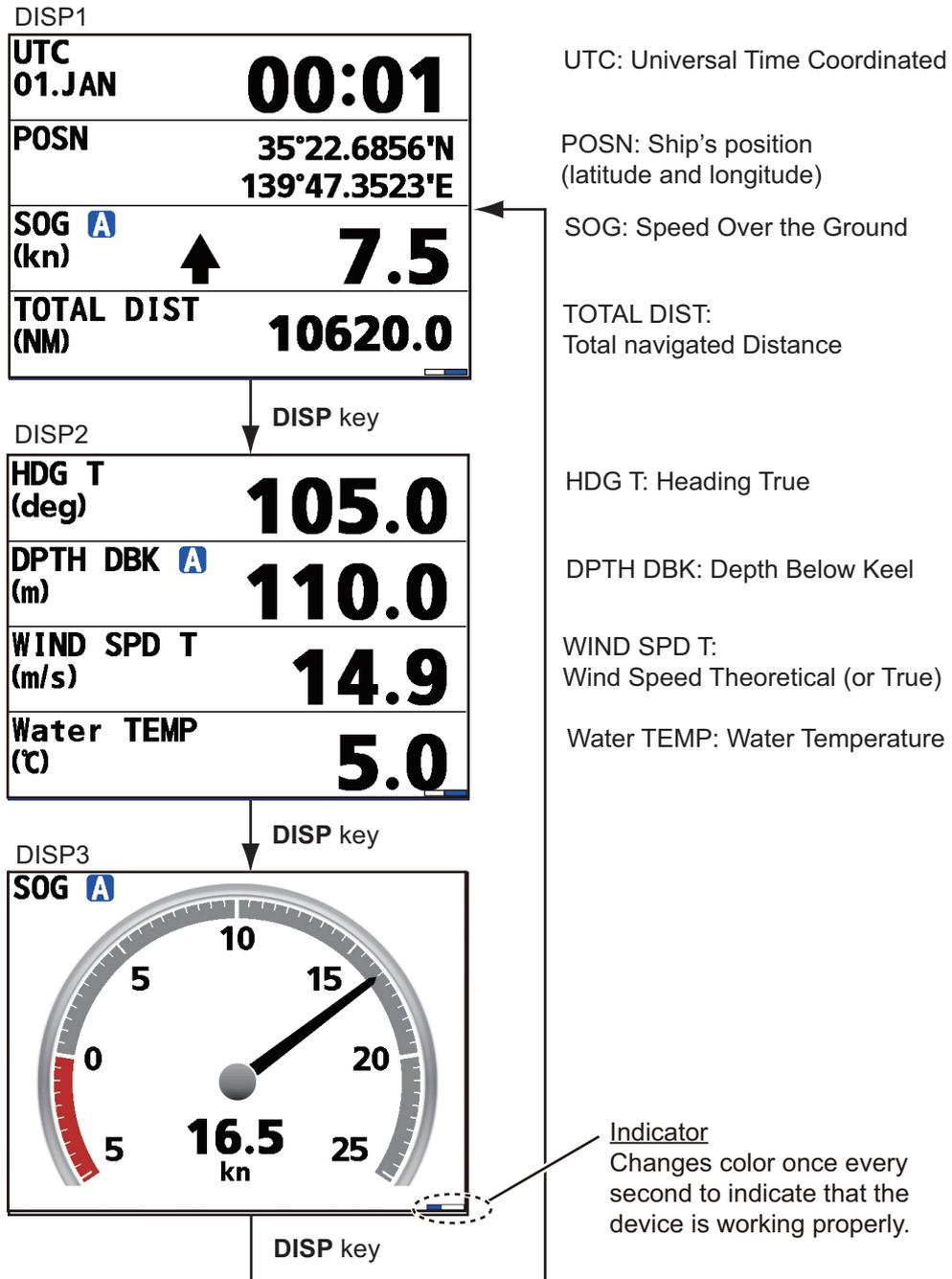

*: DISP4 and DISP5 are not displayed in default setting.

Data screens (default)

2. MENU

2.1 Menu Description

Below is the basic procedure for menu operation.

1. Press the **MENU/ESC** key to open the menu.

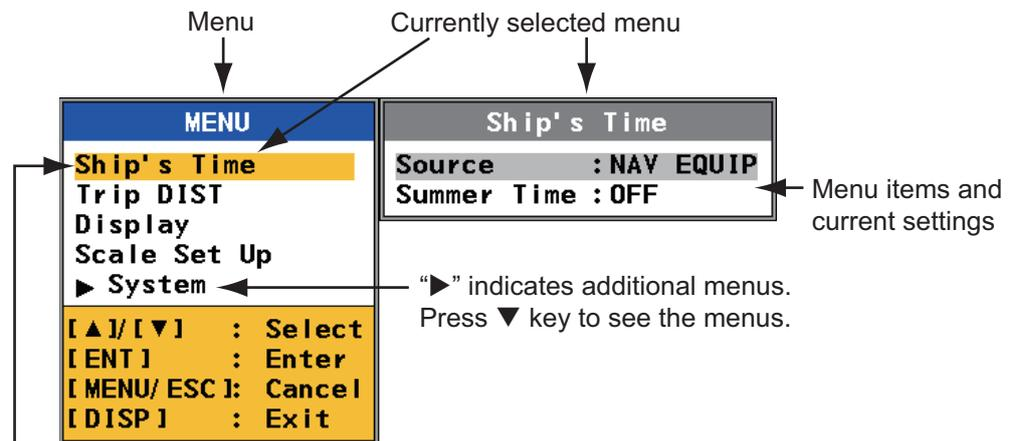

Cursor: Selected cursor is in orange.

Menu

2. Press **▲** or **▼** key to select a menu. The menu items in the right window change according to the menu selected.
3. Press the **ENT** key to switch the control to the menu items column. To switch the control from the menu items column to the menu column, press the **MENU/ESC** key.
4. Press **▲** or **▼** key to select a menu item and press the **ENT** key. A window with options for the related menu items appears.

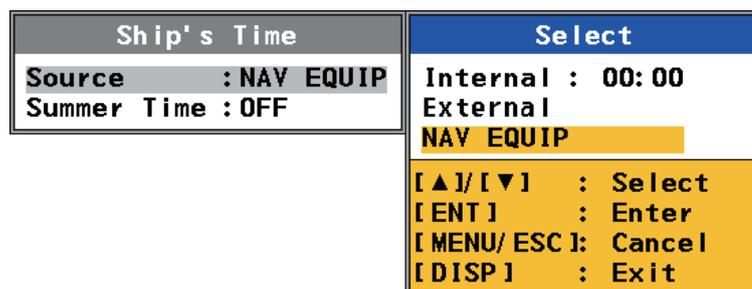

Example window

2. MENU

5. Press **▲** or **▼** key to select an option and press the **ENT** key. If the menu contains more layers, repeat this step. When the value setting window shown below appears, press **▲** or **▼** key to set the value and press the **ENT** key. To return one layer without saving settings, press the **MENU/ESC** key.

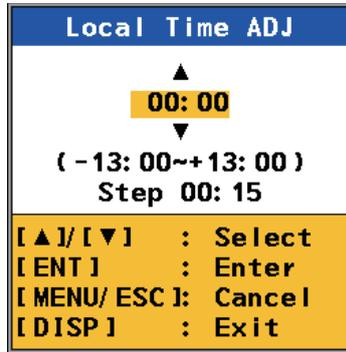

Example of value setting window

6. Press the **DISP** key to close the menu.

2.2 How to Customize the Data Screen

The RD-50 has three data screen types; [Graphic], [Digital] and [Graph]. You can select what data to display and the order to display it. Availability of data depends on the sensors connected.

1. Press the **MENU/ESC** key to open the menu.
2. Press **▲** or **▼** key to select [Display] and press the **ENT** key.

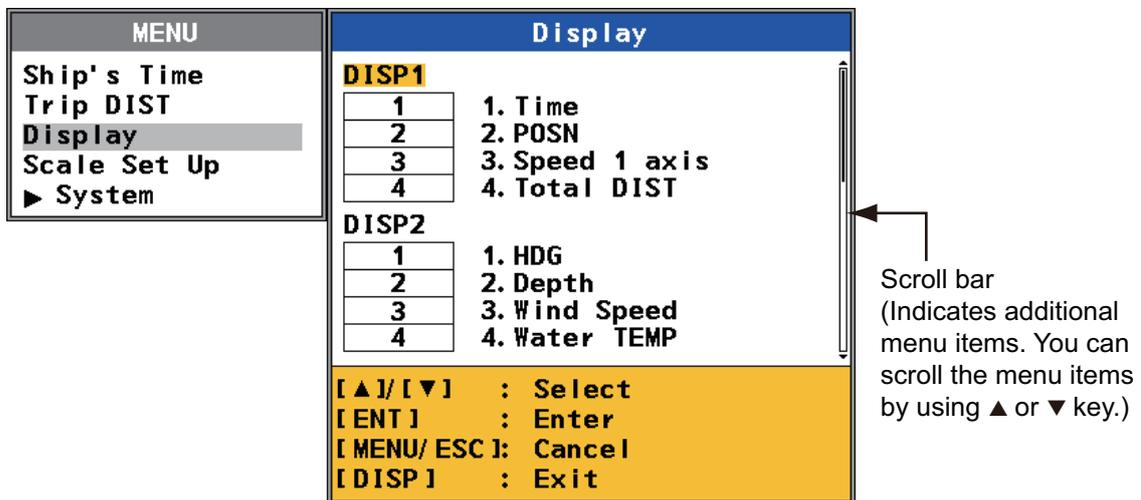

Display menu

3. Press ▲ or ▼ key to select [DISP1 (2, 3, 4 or 5)] and press the ENT key.

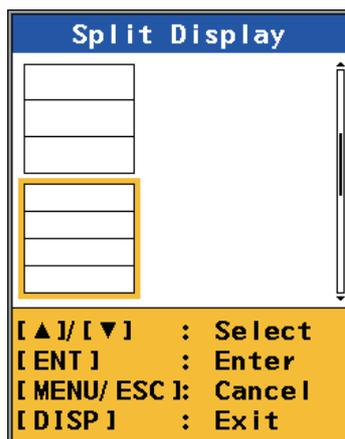

Split Display options

4. Press ▲ or ▼ key to select the screen division and press the ENT key. If you selected the no-split screen, go to step 5. If you selected the blank screen, go to step 8. For the other types, go to step 6.

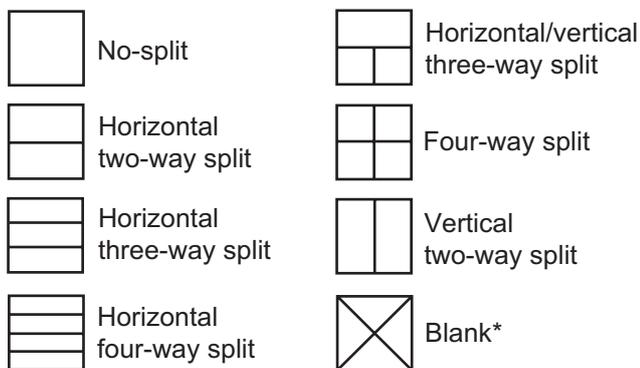

*: Can not select for the [DISP1] screen.

Screen division

5. Press ▲ or ▼ key to select [Graphic], [Digital] or [Graph] in the [DISP Mode] window then press the ENT key. The available menu items depend on the selected screen division.

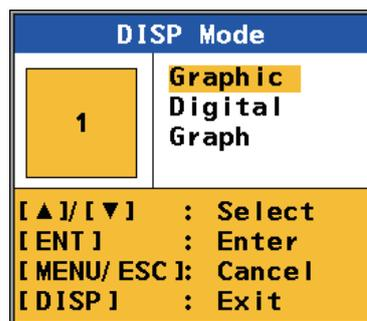

DISP Mode options

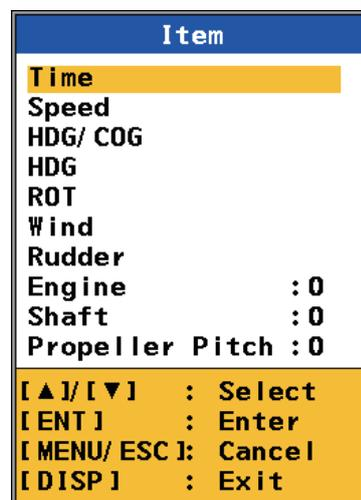

Item options

2. MENU

6. Press ▲ or ▼ key to select the item(s) in the [Item] window and press the **ENT** key. The available items depend on the screen division selected at step 4 or the DISP mode selected at step 5. For details, see the APPENDIX 2. If you selected [Engine], [Shaft] or [Propeller Pitch] in the [Graphic] or [Digital] menus, go to step 7. For the others, go to step 8.
7. Press ▲ or ▼ key to select the number of engines, shafts or propeller pitch and press the **ENT** key.

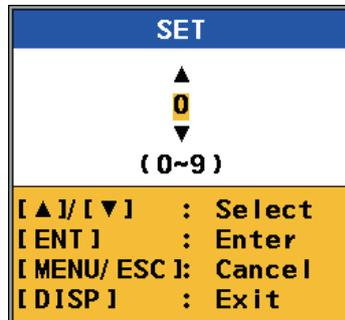

SET setting window

8. Press the **DISP** key to close the menu.

To switch the data screen, press the **DISP** key on the data screen. The mode changes in the sequence of DISP1 → DISP2 → DISP3 → DISP4 → DISP5 → DISP1 → ...

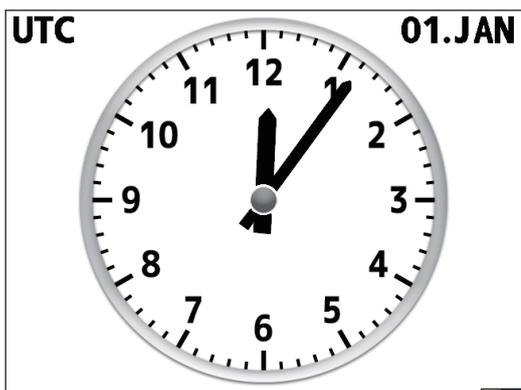

Split Display: No-split
DISP Mode: Graphic
Item: Time



Split Display: No-split
DISP Mode: Graphic
Item: HDG

HDG T (deg)	242.0
COG T (deg)	248.0
TOTAL DIST (NM)	12370.0
Water TEMP (°C)	0.5

Split Display: Horizontal four-way split
DISP Mode: Digital
Item: HDG, COG, Total DIST, Water TEMP

POSN	TO WPT No.TOKYO
35°25.7706'N 135°57.6206'E	35°21.1263'N 139°45.7930'E

Split Display: Vertical two-way split
DISP Mode: Digital
Item: POSN, WPT

DPTH KEEL (m)		130.0
WIND DIR T (deg)	WIND SPD T (m/s)	050 14.9

Split Display: Horizontal/vertical three-way split
DISP Mode: Digital
Item: Depth, Wind Direction, Wind Speed

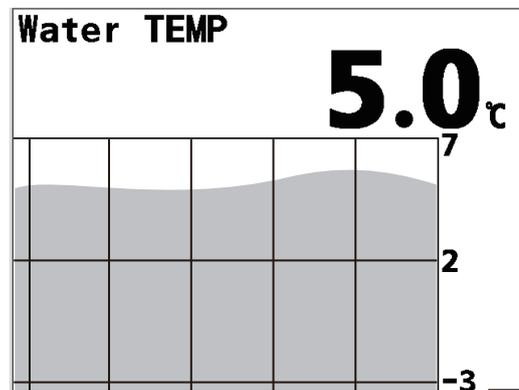

Split Display: No-split
DISP Mode: Graph
Item: Water TEMP Graph

Examples of data screen

2.3 How to Preset Scales/Indications

You can preset the scales/indications for time, ship's speed, HDG (heading)/COG (course over the ground) and wind speed/direction. You can change the scale/indication with the **MODE** key of the RD-501 (see section 2.16).

1. Press the **MENU/ESC** key to open the menu.
2. Press **▲** or **▼** key to select [Scale Set Up] and press the **ENT** key.

MENU	Scale Set Up
Ship's Time	Unit
Trip DIST	Mode
Display	Speed Graphic
Scale Set Up	Depth Graph
▶ System	Water TEMP Graph
	Rudder
	Engine/ Shaft
	Digital on Graphic : ON
	Rudder Order Symbol : ON
	Direction Symbol : Arrows
	Symbol Location : Left
	[▲]/[▼] : Select
	[ENT] : Enter
	[MENU/ESC] : Cancel
	[DISP] : Exit

Scale Set Up menu

3. Press **▲** or **▼** key to select [Mode] and press the **ENT** key.

Display
DISP1
DISP2
DISP3
DISP4
DISP5
[▲]/[▼] : Select
[ENT] : Enter
[MENU/ESC] : Cancel
[DISP] : Exit

Display options

4. Press **▲** or **▼** key to select [DISP1 (2, 3, 4 or 5)], for which you preset the scales/indications, and press the **ENT** key.

DISP1
Time : UTC
Speed : Auto
HDG/ COG : True
Wind : True
[▲]/[▼] : Select
[ENT] : Enter
[MENU/ESC] : Cancel
[DISP] : Exit

DISP1 (2, 3, 4, 5) options

5. Press ▲ or ▼ key to select [Time] and press the **ENT** key.

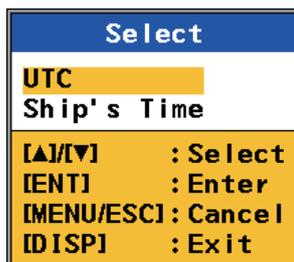

Time options

6. Press ▲ or ▼ key to select [UTC] or [Ship's Time] then press the **ENT** key.
[UTC]: Universal time coordinated
[Ship's Time]: Local time (For [Ship's Time], see section 2.14.)
7. Press ▲ or ▼ key to select [Speed] and press the **ENT** key.

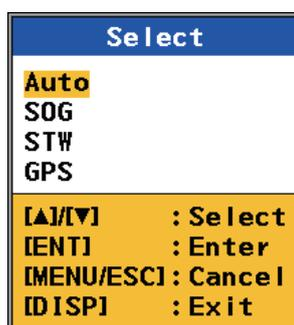

Speed options

8. Press ▲ or ▼ key to select [Auto], [SOG], [STW] or [GPS] then press the **ENT** key.
[Auto]: The speed data is displayed in order of priority, SOG, STW and GPS. The SOG has the highest, while GPS has the lowest priority. That is, when SOG, STW and GPS data are available, the SOG data is displayed. If the SOG data is not available, the STW data is displayed. **A** appears at the upper-left corner of the screen when the [Auto] mode is active.
[SOG], [STW]: The speed data from the doppler sonar, doppler log or speed log
[GPS]: The data from the navigation equipment (SOG data from a GPS navigator)
9. Press ▲ or ▼ key to select [HDG/COG] and press the **ENT** key.

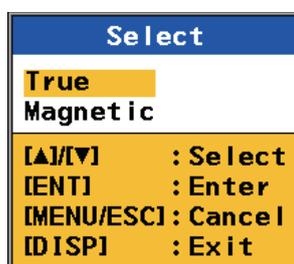

HDG/COG options

10. Press ▲ or ▼ key to select [True] or [Magnetic] then press the **ENT** key.
[True]: The bearing measured with true North as the reference direction.
[Magnetic]: The bearing measured with magnetic north as the reference direction.

11. Press ▲ or ▼ key to select [Wind] and press the **ENT** key.

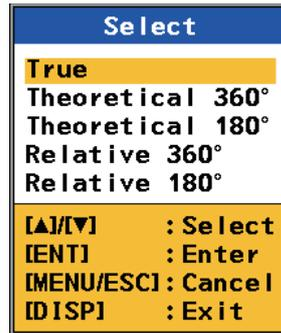

Wind options

12. Press ▲ or ▼ key to select [True], [Theoretical 360° (or 180°)] or [Relative 360° (or 180°)] then press the **ENT** key.

[True]: The wind angle measured with true North as the reference angle and the wind speed as if the ship is stationary. "T" is displayed on the screen.

[Theoretical 360°/180°]: Theoretical or calculated wind angle. The wind angle relative to the ship's bow and the wind speed as if the ship is stationary. The wind graphic scale for [Theoretical 360°] indicates 0° to 360°, for [Theoretical 180°] indicates 0° to 180° for port and starboard. "TH" is displayed on the screen.

[Relative 360°/180°]: Relative or apparent wind angle. The wind angle relative to the ship's bow and the wind speed relative to the moving ship. The wind graphic scale for [Relative 360°] indicates 0° to 360°, for [Relative 180°] indicates 0° to 180° for port and starboard. "R" is displayed on the screen.

Note 1: The indication of the wind angle (port or starboard) is displayed at the bottom of the screen when you select [Theoretical 180°] or [Relative 180°].

Note 2: The RD-50 can show wind speed/direction data received from the respective sensors, however, the RD-50 cannot convert these values from true to relative or vice versa.

13. Press the **DISP** key to close the menu.

2.4 How to Set the Speed Graphic Range

You can customize the astern and ahead speed scales for the speed graphic.

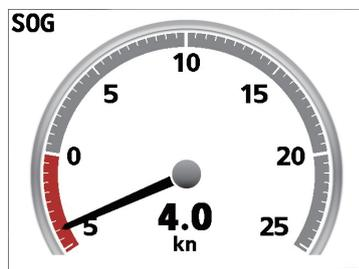

Astern SPD Scale: 5 kn
Ahead SPD Scale: 25 kn
Symbol Location*: Left (The pointer rotates clockwise as ship's speed increases.)

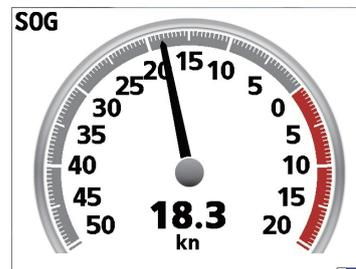

Astern SPD Scale: 20 kn
Ahead SPD Scale: 50 kn
Symbol Location*: Right (The pointer rotates counterclockwise as ship's speed increases.)

*: See section 2.12.

Examples of the speed graphic

1. Press the **MENU/ESC** key to open the menu.
2. Press **▲** or **▼** key to select [Scale Set Up] and press the **ENT** key.
3. Press **▲** or **▼** key to select [Speed Graphic] and press the **ENT** key.

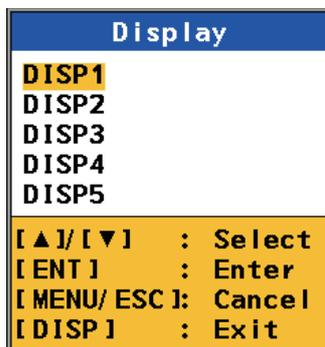

Display options

4. Press **▲** or **▼** key to select [DISP1 (2, 3, 4 or 5)], which shows the speed graphic screen, and press the **ENT** key.

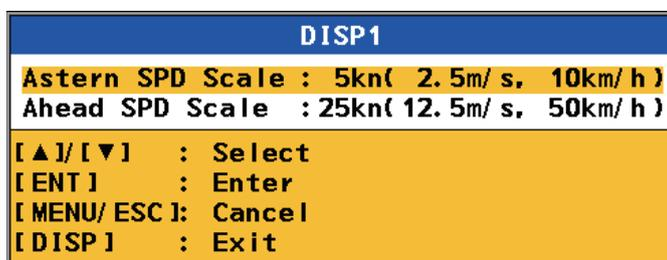

Speed Graphic Range options

5. Press **▲** or **▼** key to select [Astern SPD Scale] or [Ahead SPD Scale] then press the **ENT** key.

[Astern SPD Scale]: Set the astern range. (The scale is reddish brown.)

[Ahead SPD Scale]: Set the ahead range. (The scale is gray.)



Astern (Ahead) SPD Scale options

6. Press **▲** or **▼** key to select a range and press the **ENT** key.
Note: You can not set the total range of astern scale and ahead scale more than 70 kn.
7. Repeat steps 5 and 6 to set the astern range or the ahead range.
8. Press the **DISP** key to close the menu.

2.5 Depth Graph

You can customize the scale range, period for the horizontal axis and graph appearance for the depth graph.

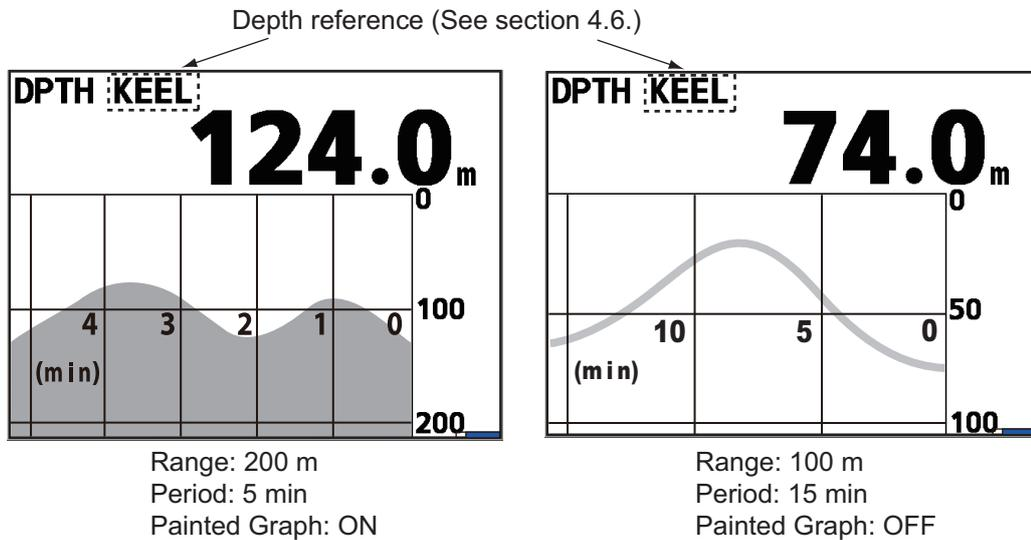

Examples of Depth Graph

1. Press the **MENU/ESC** key to open the menu.
2. Press **▲** or **▼** key to select [Scale Set Up] and press the **ENT** key.
3. Press **▲** or **▼** key to select [Depth Graph] and press the **ENT** key.

Display	
DISP1	
DISP2	
DISP3	
DISP4	
DISP5	
[▲]/[▼]	: Select
[ENT]	: Enter
[MENU/ESC]	: Cancel
[DISP]	: Exit

Display options

4. Press **▲** or **▼** key to select [DISP1 (2, 3, 4 or 5)], which shows the depth graph, and press the **ENT** key.

DISP1	
Range	: Auto
Period	: 15min
Painted Graph	: ON
Graph Clear	
[▲]/[▼]	: Select
[ENT]	: Enter
[MENU/ESC]	: Cancel
[DISP]	: Exit

Depth Graph options

5. Press **▲** or **▼** key to select [Range] and press the **ENT** key.

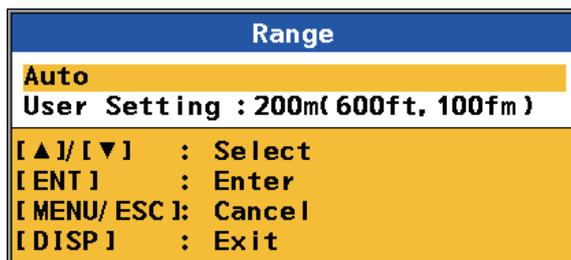

Range options

6. Press **▲** or **▼** key to select [Auto] or [User Setting] then press the **ENT** key. If you selected [Auto], go to step 8. If you selected [User Setting], the following window appears. Press **▲** or **▼** key to select range and press the **ENT** key.

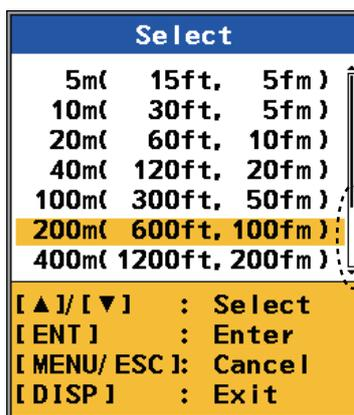

← Scroll screen with **▼** key, to see other options.

User Setting options

[Auto]:

- When the depth exceeds 100 m in the 100 m range, the range is automatically changed to 200 m.
 - When the depth becomes 80% or less of the range which is one rank lower than the current setting range, the range automatically goes down one rank. For example, when the depth comes to 32 m or less in the 100 m range, the range is automatically changed to 40 m.
 - When the depth drops-off to 1000 m in the 100 m range, the range is automatically changed to 1000 m.
7. Press the **MENU/ESC** key.
8. Press **▲** or **▼** key to select [Period] and press the **ENT** key.

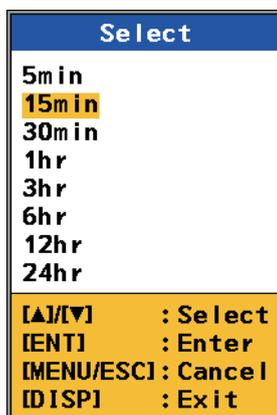

Period options

2. MENU

- Press **▲** or **▼** key to select the period for the horizontal axis and press the **ENT** key.
- Press **▲** or **▼** key to select [Painted Graph] and press the **ENT** key.

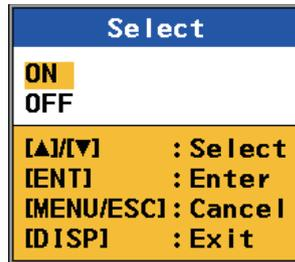

Painted Graph options

- Press **▲** or **▼** key to select [ON] or [OFF] then press the **ENT** key.
[ON]: Filled
[OFF]: Line only

- Press the **DISP** key to close the menu.

To clear the graph, select [Graph Clear] (see above step 5) → [Yes] then press the **ENT** key.

2.6 Water TEMP Graph

You can customize the scale range, period for the horizontal axis and graph appearance for the water temperature graph.

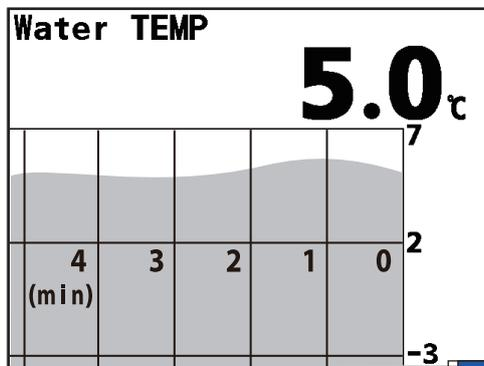

Range: 10 °C (20 °F)
Period: 5 min
Painted Graph: ON

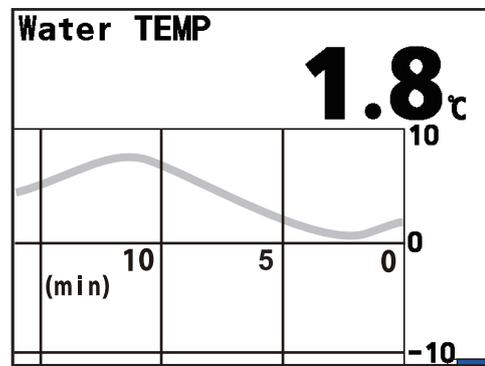

Range: 20 °C (40 °F)
Period: 15 min
Painted Graph: OFF

Examples of Water TEMP Graph

- Press the **MENU/ESC** key to open the menu.
- Press **▲** or **▼** key to select [Scale Set Up] and press the **ENT** key.

3. Press ▲ or ▼ key to select [Water TEMP Graph] and press the **ENT** key.

Display	
DISP1	
DISP2	
DISP3	
DISP4	
DISP5	
[▲]/[▼]	: Select
[ENT]	: Enter
[MENU/ESC]	: Cancel
[DISP]	: Exit

Display options

4. Press ▲ or ▼ key to select [DISP1 (2, 3, 4 or 5)], which shows the water temp graph screen, and press the **ENT** key.

DISP1	
Range	: 10℃(20℉)
Period	: 15min
Painted Graph	: ON
Graph Clear	
[▲]/[▼]	: Select
[ENT]	: Enter
[MENU/ESC]	: Cancel
[DISP]	: Exit

Water TEMP Graph options

5. Press ▲ or ▼ key to select [Range] and press the **ENT** key.

Select	
5℃(10℉)	
10℃(20℉)	
20℃(40℉)	
[▲]/[▼]	: Select
[ENT]	: Enter
[MENU/ESC]	: Cancel
[DISP]	: Exit

Range options

6. Press ▲ or ▼ key to select [5°C (10°F)], [10°C (20°F)] or [20°C (40°F)] then press the **ENT** key.
7. Press ▲ or ▼ key to select [Period] and press the **ENT** key.

Select	
5min	
15min	
30min	
1hr	
3hr	
6hr	
12hr	
24hr	
[▲]/[▼]	: Select
[ENT]	: Enter
[MENU/ESC]	: Cancel
[DISP]	: Exit

Period options

2. MENU

8. Press ▲ or ▼ key to select the period for the horizontal axis and press the **ENT** key.
9. Press ▲ or ▼ key to select [Painted Graph] and press the **ENT** key.

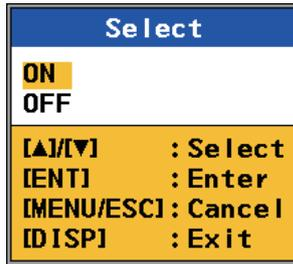

Painted Graph options

10. Press ▲ or ▼ key to select [ON] or [OFF] then press the **ENT** key.
[ON]: Filled
[OFF]: Line only
11. Press the **DISP** key to close the menu.

To clear the graph, select [Graph Clear] (see above step 5) → [Yes] then press the **ENT** key.

2.7 Rudder Graphic

2.7.1 How to set the range for rudder graphic and position for rudder

You can customize the rudder angle range and rudder position for the rudder graphic. The rudder order symbol can be shown or hidden.

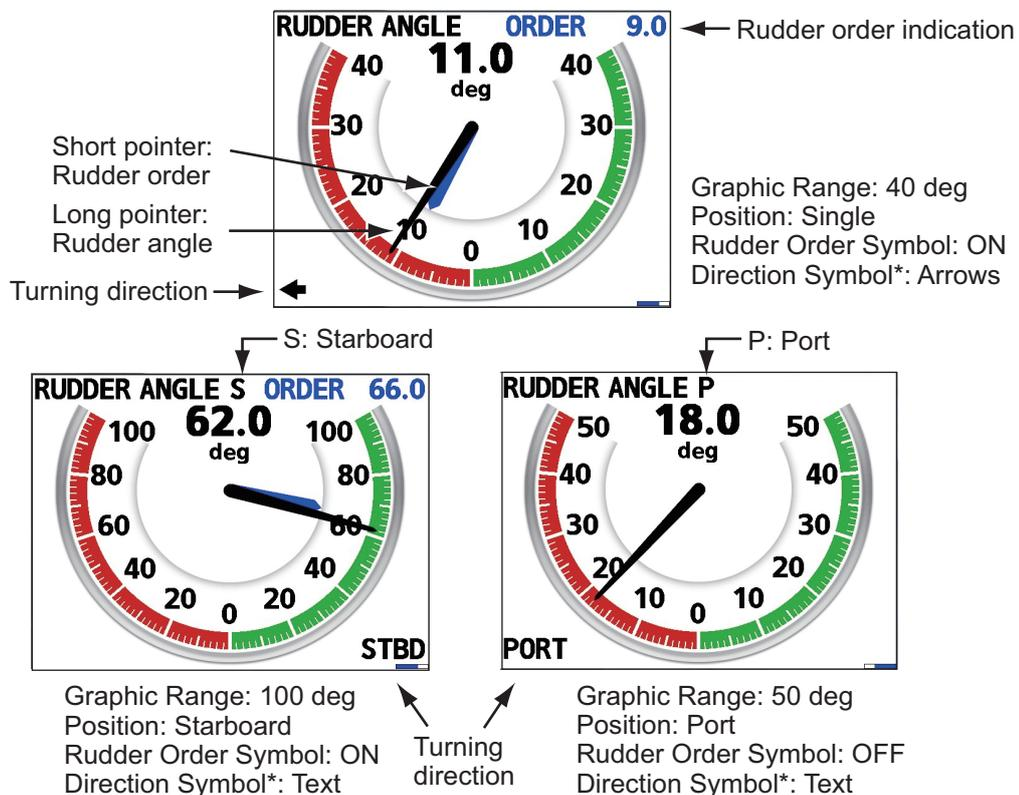

*: See section 2.11 for [Direction Symbol].

Examples of Rudder Graphic

1. Press the **MENU/ESC** key to open the menu.
2. Press **▲** or **▼** key to select [Scale Set Up] and press the **ENT** key.
3. Press **▲** or **▼** key to select [Rudder] and press the **ENT** key.

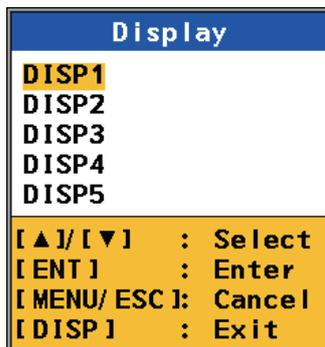

Display options

4. Press **▲** or **▼** key to select [DISP1 (2, 3, 4 or 5)], which you select for the rudder graphic screen, and press the **ENT** key.

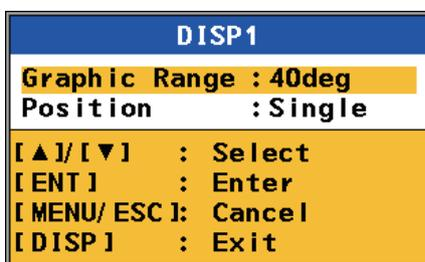

Rudder options

5. Press **▲** or **▼** key to select [Graphic Range] and press the **ENT** key.



Graphic Range setting window

6. Press **▲** or **▼** key to select range and press the **ENT** key.

2. MENU

7. Press ▲ or ▼ key to select [Position] and press the **ENT** key.

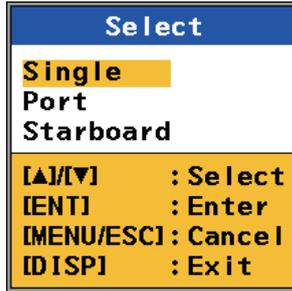

Position options

8. Press ▲ or ▼ key to select [Single], [Port] or [Starboard] then press the **ENT** key.
[Single]: One rudder on the ship
[Port]: Display the data for port rudder
[Starboard]: Display the data for starboard rudder
9. Press the **DISP** key to close the menu.

2.7.2 Rudder order symbol

You can turn on/off the rudder order indication.

1. Press the **MENU/ESC** key to open the menu.
2. Press ▲ or ▼ key to select [Scale Set Up] and press the **ENT** key.
3. Press ▲ or ▼ key to select [Rudder Order Symbol] and press the **ENT** key.

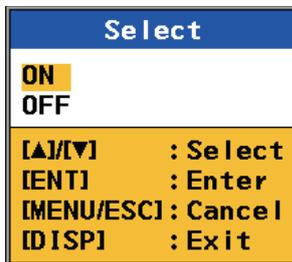

Rudder Order Symbol options

4. Press ▲ or ▼ key to select [ON] or [OFF] then press the **ENT** key.
5. Press the **DISP** key to close the menu.

2.8 Engine/Shaft Graphic

You can set the scale range for the engine/shaft graphic.

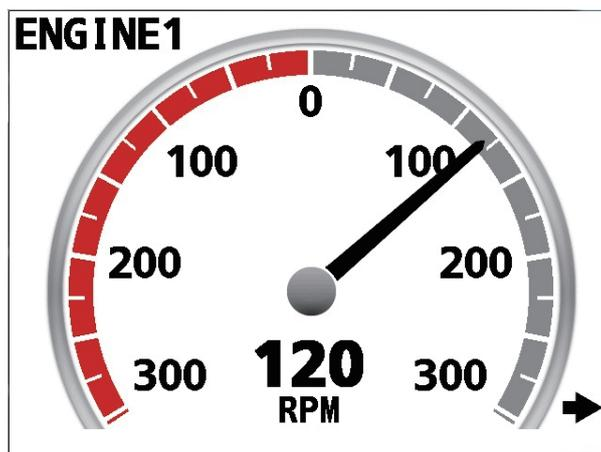

Example of Engine screen (in case of 300 RPM for display range)

1. Press the **MENU/ESC** key to open the menu.
2. Press **▲** or **▼** key to select [Scale Set Up] and press the **ENT** key.
3. Press **▲** or **▼** key to select [Engine/Shaft] and press the **ENT** key.

Display	
DISP1 :	300RPM
DISP2 :	300RPM
DISP3 :	300RPM
DISP4 :	300RPM
DISP5 :	300RPM
[▲]/[▼]	: Select
[ENT]	: Enter
[MENU/ESC]	: Cancel
[DISP]	: Exit

Display options

4. Press **▲** or **▼** key to select [DISP1 (2, 3, 4 or 5)], which shows the engine or shaft graphic screen, and press the **ENT** key.

Select	
	100RPM
	150RPM
	200RPM
	250RPM
	300RPM
	400RPM
	500RPM
	750RPM
	1000RPM
[▲]/[▼]	: Select
[ENT]	: Enter
[MENU/ESC]	: Cancel
[DISP]	: Exit

Engine/Shaft options

5. Press **▲** or **▼** key to select the range and press the **ENT** key.
6. Press the **DISP** key to close the menu.

2.9 How to Show/Hide the Digital Indication

You can show/hide the digital indication on the graphic screen for speed, ROT, rudder, engine, shaft and propeller pitch.

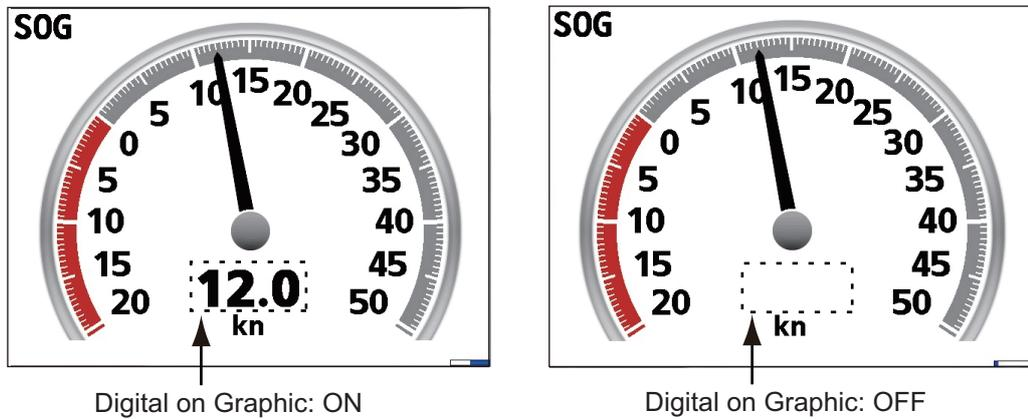

Digital indication ON/OFF

1. Press the **MENU/ESC** key to open the menu.
2. Press **▲** or **▼** key to select [Scale Set Up] and press the **ENT** key.
3. Press **▲** or **▼** key to select [Digital on Graphic] and press the **ENT** key.

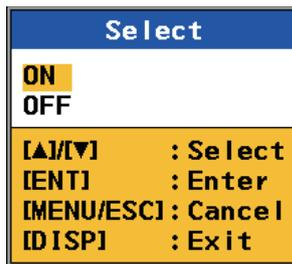

Digital on Graphic options

4. Press **▲** or **▼** key to select [ON] or [OFF] then press the **ENT** key.
5. Press the **DISP** key to close the menu.

2.10 Units of Measurement

You can preset the units of measurement for ship speed, distance, depth, wind speed and water temperature. You can change these units with the **UNIT** key of the RD-501 (see section 2.16).

1. Press the **MENU/ESC** key to open the menu.
2. Press **▲** or **▼** key to select [Scale Set Up] and press the **ENT** key.

3. Press ▲ or ▼ key to select [Unit] and press the **ENT** key.

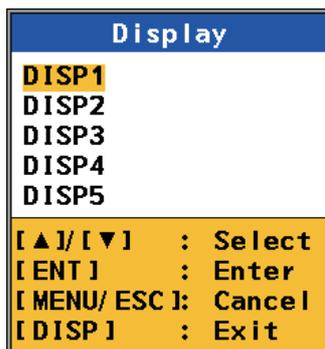

Display options

4. Press ▲ or ▼ key to select [DISP1 (2, 3, 4 or 5)], for which you preset the units of measurement, and press the **ENT** key.

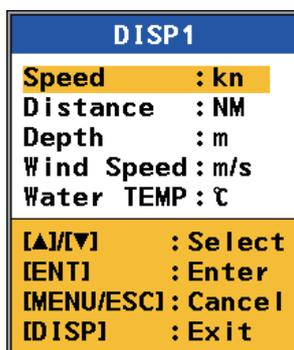

Unit options

5. Press ▲ or ▼ key to select [Speed], [Distance], [Depth], [Wind Speed] or [Water TEMP] then press the **ENT** key.

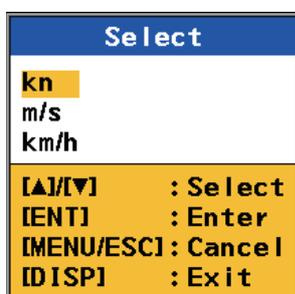

Speed

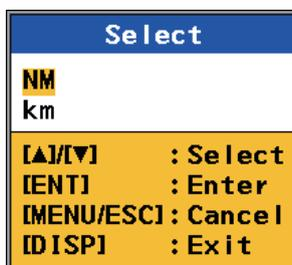

Distance

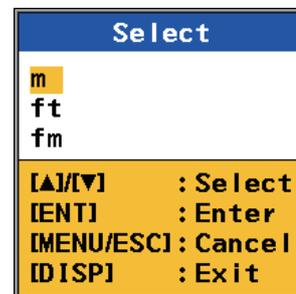

Depth

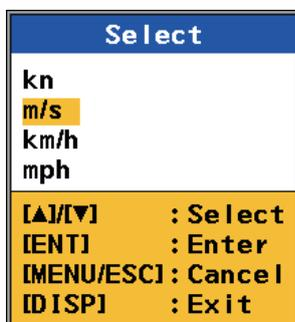

Wind Speed

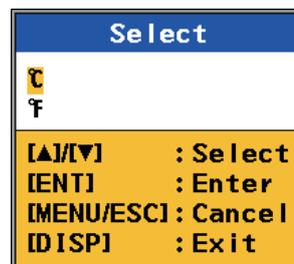

Water TEMP

Speed, Distance, Depth, Wind Speed, Water TEMP options

6. Press ▲ or ▼ key to select each unit and press the **ENT** key.
7. Press the **DISP** key to close the menu.

2.11 Direction Symbol

You can show the direction symbol by [Arrows] or [Text].

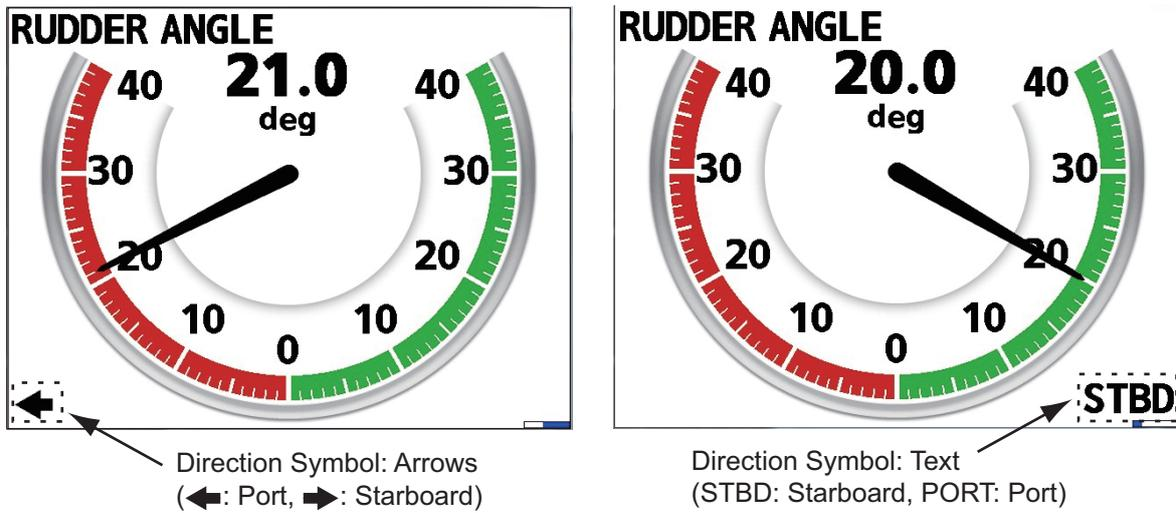

Direction Symbol: Arrows/Text

1. Press the **MENU/ESC** key to open the menu.
2. Press **▲** or **▼** key to select [Scale Set Up] and press the **ENT** key.
3. Press **▲** or **▼** key to select [Direction Symbol] and press the **ENT** key.

Select	
Arrows	
Text	
[▲]/[▼]	: Select
[ENT]	: Enter
[MENU/ESC]	: Cancel
[DISP]	: Exit

Direction Symbol options

4. Press **▲** or **▼** key to select [Arrows] or [Text] then press the **ENT** key.
5. Press the **DISP** key to close the menu.

2.12 Symbol Location

You can display the left-right reversal screen, including rotation direction, for the following graphic menus: Speed, ROT, Wind (only for Theoretical/Relative 180°), Rudder, Engine, Shaft, Propeller Pitch

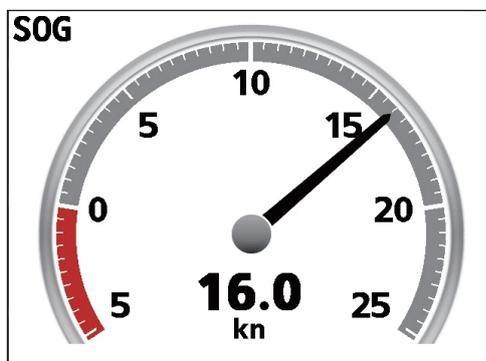

Symbol Location: Left
(The pointer rotates clockwise as ship's speed increases.)

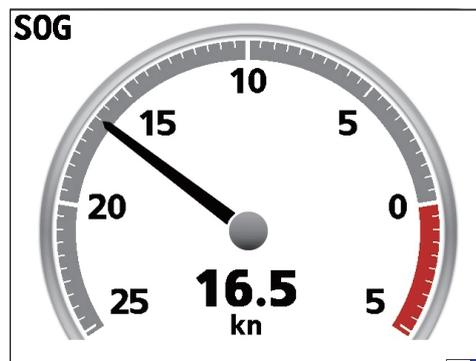

Symbol Location: Right
(The pointer rotates counterclockwise as ship's speed increases.)

Symbol Location: Left/Right

When the arrow is displayed on the digital screen for the following menus, you can display the arrow in left-right reversal. HDG/Speed 3 axis, Speed 2 (or 3) axis, ROT, Wind Direction, Rudder Angle, Rudder Angle Order

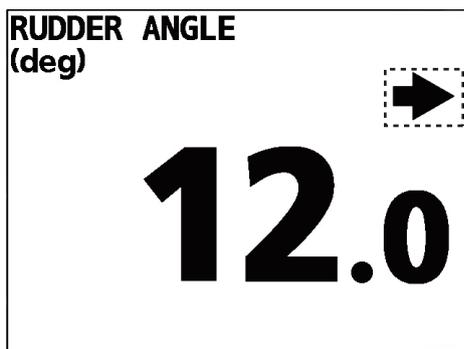

Symbol Location: Left

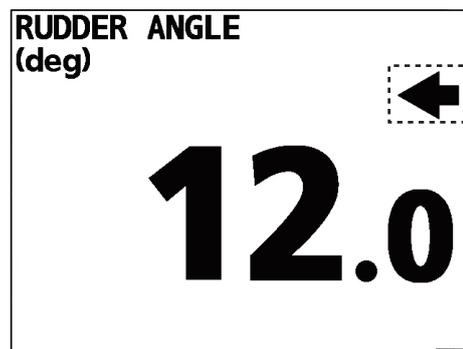

Symbol Location: Right

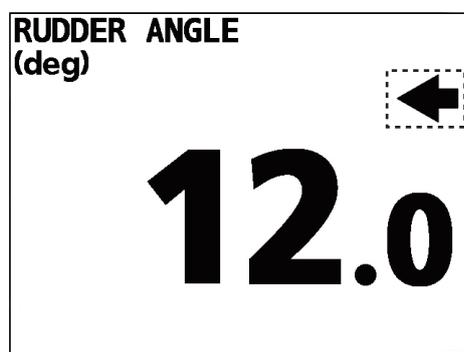

Symbol Location: Left

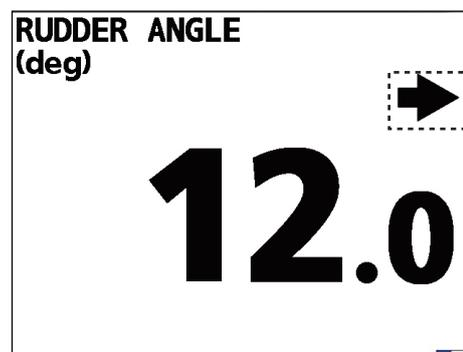

Symbol Location: Right

1. Press the **MENU/ESC** key to open the menu.
2. Press **▲** or **▼** key to select [Scale Set Up] and press the **ENT** key.

2. MENU

- Press ▲ or ▼ key to select [Symbol Location] and press the **ENT** key.

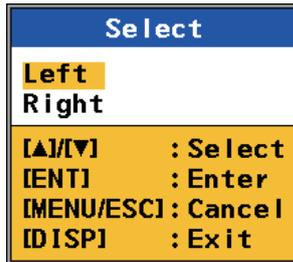

Symbol Location options

- Press ▲ or ▼ key to select [Left] or [Right] then press the **ENT** key.
- Press the **DISP** key to close the menu.

2.13 System Menu

There are five menus in the [System] menu: [Wind Average], [BRILL], [Speed Select], [TESTS] and [User RESET]. For [TESTS] and [User RESET] menus, see sections 3.3, 3.4 and 3.5.

[Wind Average]: Select the wind averaging time to smooth wind data. The longer the time setting, the more the data is smoothed. The shorter the time setting, the more the wind angle and speed fluctuate. To find the momentary wind angle and speed, select the shorter time. [No Averaging] does not smooth wind data and the measured value is always displayed.

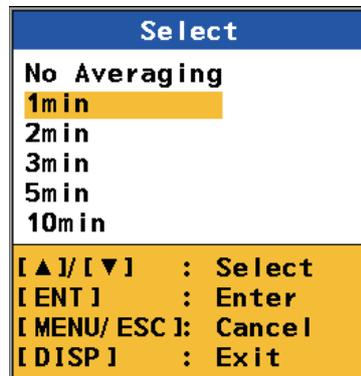

Wind Average options

[BRILL]: Set the key brilliance and the offset for the screen brilliance.

- [Key BRILL]:** Set the key brilliance. [8] is the brightest.

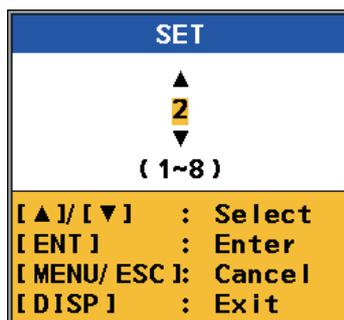

Key BRILL setting window

- **[BRILL OFFSET]**: Set the offset for screen brilliance for the RD-50 (sub) so that the screen brilliance between RD-50 (main) and RD-50 (sub) are the same. [-3] is the darkest and [3] is the brightest.

Note: This function is not available for the RD-50 (main). Main or sub is determined according to the mounting location when you install a RD-50.

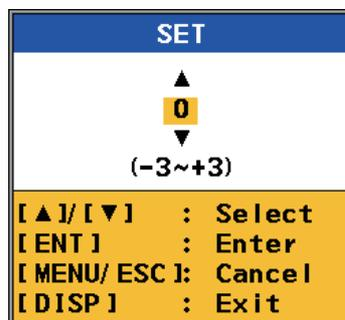

BRILL OFFSET setting window

[Speed Select]: Select the indication of the ship's speed for the speed graphic and speed 1 axis from [Forward-After] or [Vector].

[Forward-After]: Display the ship's speed for the direction of bow and stern. Text or arrow* indication appears (*: only for speed 1 axis).

[Vector]: Display the ship's speed taking into account current (tide) or wind, that is the ship's speed of the actual moving direction. The movement direction indicator is not displayed.

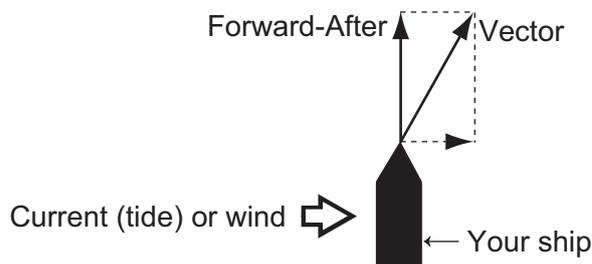

Note: Text indication: [Direction Symbol] → [Text] on the [Scale Set Up] menu (see section 2.11) → "FWD" or "AFT" appears on the screen.

Arrow indication: [Direction Symbol] → [Arrows] on the [Scale Set Up] menu → The up-arrow or down-arrow appears on the speed 1 axis (not for speed graphic) screen.

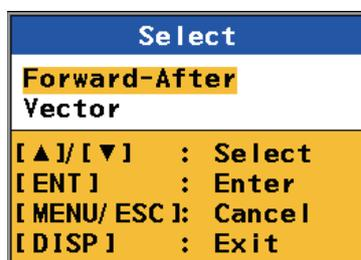

Speed Select options

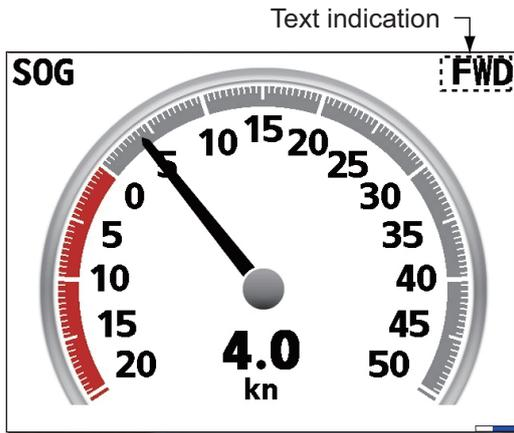

Display: Speed (Graphic)
Speed Select: Forward-After
Direction Symbol: Text

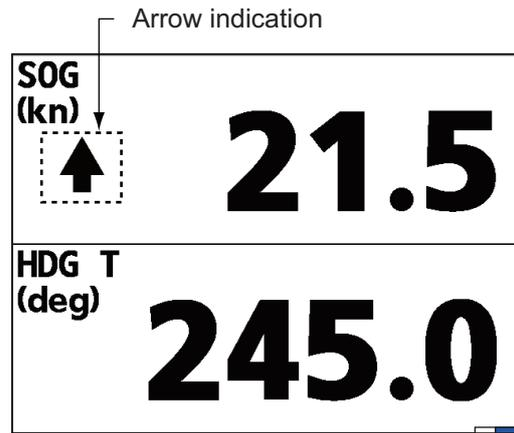

Display: Speed 1 axis
Speed Select: Forward-After
Direction Symbol: Arrows

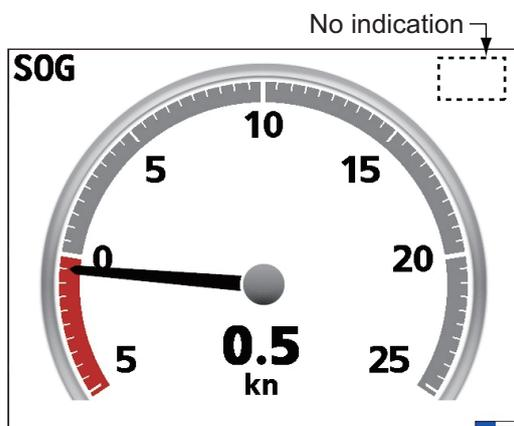

Display: Speed (Graphic)
Speed Select: Vector
Direction Symbol: Arrows/Text

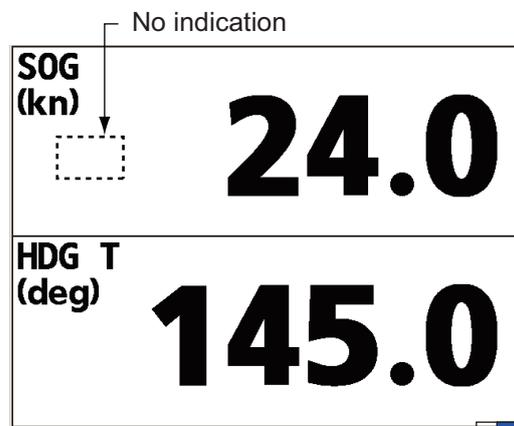

Display: Speed 1 axis
Speed Select: Vector
Direction Symbol: Arrows/Text

Speed Select: Forward-After/Vector

2.14 Time Setup

2.14.1 How to select the time source

You can select the time source from [Internal], [External] or [NAV EQUIP].

1. Press the **MENU/ESC** key to open the menu.
2. Press **▲** or **▼** key to select [Ship's Time] and press the **ENT** key.

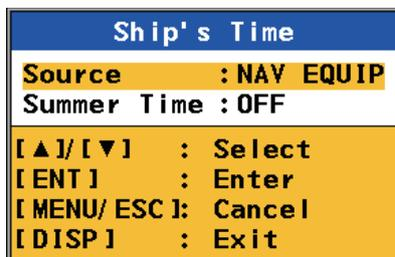

Ship's Time options

3. Press **▲** or **▼** key to select [Source] and press the **ENT** key.

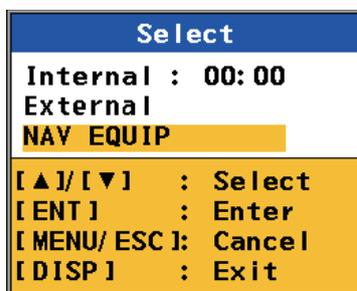

Source options

4. Press **▲** or **▼** key to select [Internal], [External] or [NAV EQUIP] then press the **ENT** key. If you selected [Internal], go to step 5. For the others, go to step 6.
[Internal]: Display the local time using own RD-50 data which is set at step 5.
[External]: Only for the RD-50 (sub). When you connect multiple RD-50s in a daisy chain, display the time using the RD-50 (main) data. In this case the RD-50 (main) should be set to [Internal] or [NAV EQUIP]. When you set the [Remote Dimmer] to [Main] on the [Service menu], this option is not available.
[NAV EQUIP]: Display the time data from the navigational equipment.
5. For [Internal], press **▲** or **▼** key to set the time differences from UTC (Universal Time Coordinated) at 15 minutes intervals and press the **ENT** key.

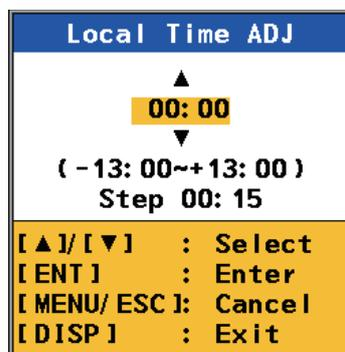

Internal setting window

2. MENU

6. Press the **DISP** key to close the menu.

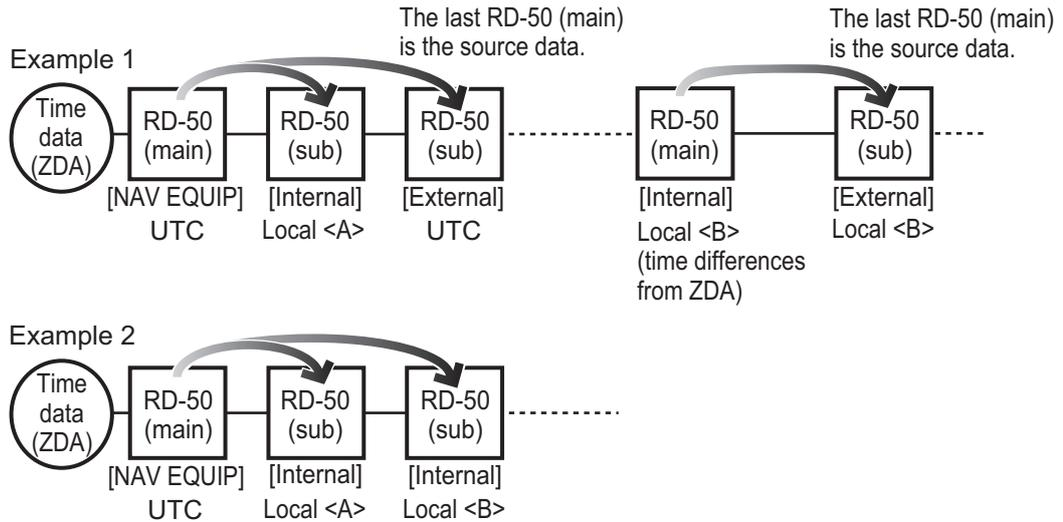

Examples for time source setting in the daisy chain connection

2.14.2 How to set the summer time

You can show the time in daylight saving time.

1. Press the **MENU/ESC** key to open the menu.
2. Press **▲** or **▼** key to select [Ship's Time] and press the **ENT** key.
3. Press **▲** or **▼** key to select [Summer Time] and press the **ENT** key.

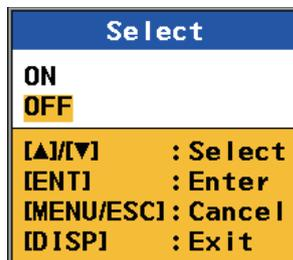

Summer Time options

4. Press **▲** or **▼** key to select [ON] or [OFF] then press the **ENT** key. Select [ON] to show daylight saving time.
5. Press the **DISP** key to close the menu.

2.15 Trip Distance

You can select the distance data for the trip distance, from [Internal] or [External]. Also, you can set the preset distance to display the trip distance.

1. Press the **MENU/ESC** key to open the menu.
2. Press **▲** or **▼** key to select [Trip DIST] and press the **ENT** key.

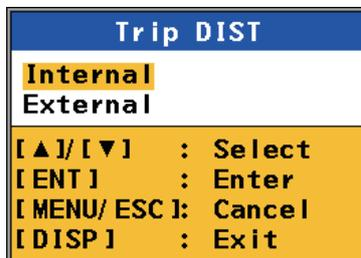

Trip DIST options

3. Press **▲** or **▼** key to select [Internal] or [External] then press the **ENT** key. If you selected [Internal], go to step 4. For [External], go to step 6.

[Internal]: Display the trip distance which is counted up based on the inner setting of this equipment. See steps 4 and 5 for how to preset distance.

[External]: Display the trip distance using data from external equipment.

Note: This equipment can not receive VLW data which is based on SOG.

4. For [Internal], press **▲** or **▼** key to select [SET] and press the **ENT** key.

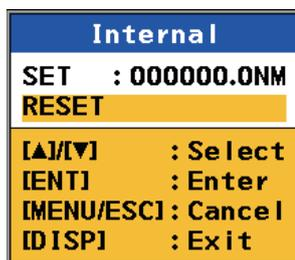

Internal options

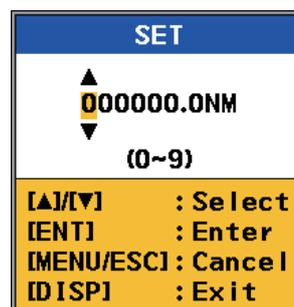

SET setting window

5. Set the preset distance. Press **▲** or **▼** key to set the value for the highest-order digit and press the **ENT** key. The cursor moves to the next digit. Repeat this step to set the value for ALL digits. To return the cursor to the upper digit, press the **MENU/ESC** key.

Note: Be sure to enter ALL digits. Otherwise the setting is not saved.

To reset the trip distance, select [RESET] and press the **ENT** key.

6. Press the **DISP** key to close the menu.

How to reset the trip distance at data screen

You can reset the trip distance by long-pressing the **ENT** key at the trip distance data screen.

Note: This operation is not available in the [External] mode.

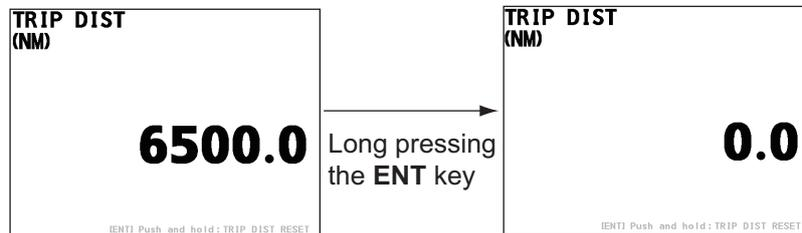
**2.16 Operation with RD-501**

You can change the scale/indication with the **MODE** key and the unit of measurement with the **UNIT** key.

Operation on the no-split screen

1. Press the **DISP** key to select the screen which you want to change the setting.
2. Press the **MODE** key or the **UNIT** key to select desired setting.

Operation on the divided screen

1. Press the **DISP** key to select the screen which you want to change the setting.
2. Press the **MODE** key or the **UNIT** key to display the cursor in yellow.
3. Press the **DISP** key to select the menu items which you want to change the setting.

Cursor (yellow) highlights currently selected menu item.

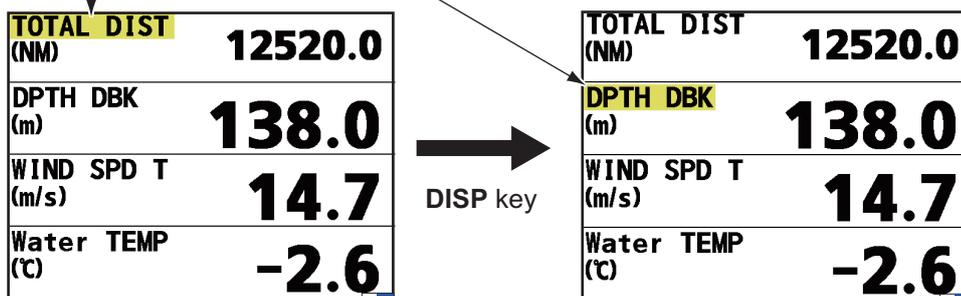

4. Press the **MODE** key or the **UNIT** key to change the setting.
5. Repeat steps 2 to 4 to change other settings.
6. Press the **DISP** key till the cursor (yellow) turns off.

3. MAINTENANCE, TROUBLE-SHOOTING

NOTICE

Do not apply paint, anti-corrosive sealant or contact spray to coating or plastic parts of the equipment.

Those items contain organic solvents that can damage coating and plastic parts, especially plastic connectors.

3.1 Maintenance

Check the following points regularly to maintain performance:

- Check that connections on the rear panel are firmly tightened and free of dust.
- Check that the ground is free of rust and the ground wire is tightly fastened.
- Remove dust or dirt from the cabinet with a soft, dry cloth. For stubborn dirt, you can use water-diluted mild detergent. Clean the cabinet with a dry cloth after you use detergent. Do not use solvents like thinner, acetone or benzene to clean the unit. They can remove paint and indications.
- Wipe the LCD carefully to prevent scratching, using LCD cleaning cloth (supplied as accessory). To remove dirt or salt deposits, use an LCD cleaner, wiping slowly with tissue paper so as to dissolve the dirt or salt. Change paper frequently so the salt or dirt will not scratch the LCD. Do not use solvents such as thinner, acetone or benzene for cleaning. Also, do not use degreaser or antifog solution, as they can strip the coating from the LCD.

3.2 Life of the Parts

Fuse replacement

The fuse in the remote display protects the equipment from overcurrent and equipment fault. If the fuse blows, find the cause before you replace the fuse. Use the correct fuse supplied as spare parts. A wrong fuse can damage the equipment.



Fuse location (Rear panel: cable cover removed)

WARNING

Use the correct fuse.

A wrong fuse can damage the equipment and cause fire.

Type	Code No.	Remarks
FGMB-A 125V 2A PBF	000-157-479-10	12-24 VDC

LCD backlight life

The life of the LCD backlight, which provides the illumination for the LCD, is approximately 50,000 hours at 25°C (77°F) (ambient temperature). The actual number of hours depends on ambient temperature and humidity. The display brilliance cannot be raised when the backlight has worn out. When brilliance cannot be raised, have a qualified technician replace the backlight.

3.3 Diagnostic Test

The diagnostic test checks the system for correct operation.

1. Press the **MENU/ESC** key to open the menu.
2. Press **▲** or **▼** key to select [TESTS] and press the **ENT** key.

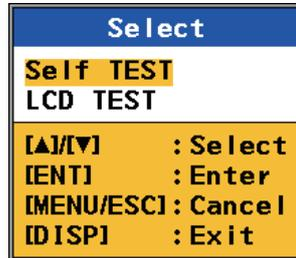

TESTS options

3. Press **▲** or **▼** key to select [Self TEST] and press the **ENT** key.

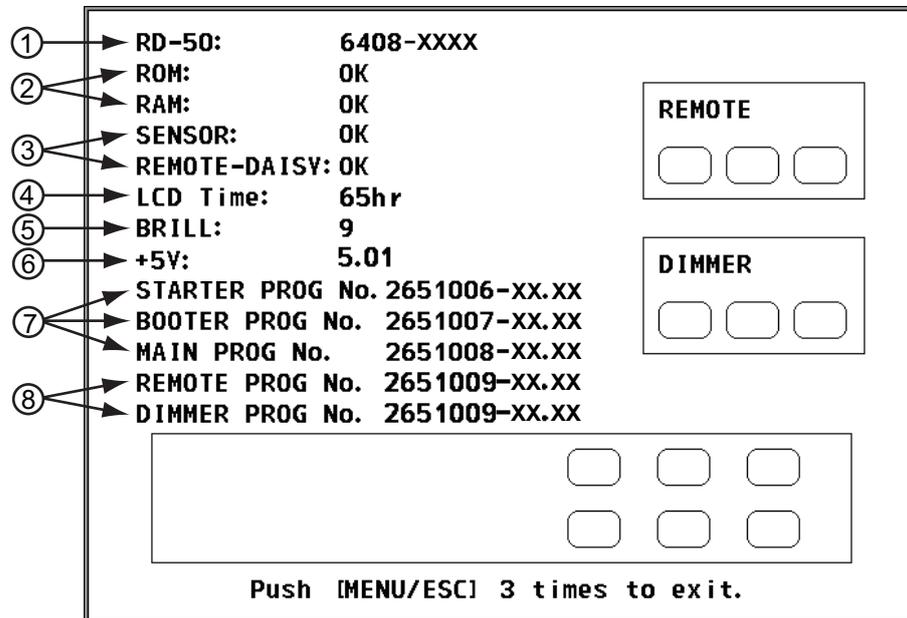

XXXX: Serial number

XX.XX: Program version number

Self TEST screen

Self test items

No.	Items	Description
1	Model name, serial number	The model name "RD-50" and its serial number are displayed.
2	ROM, RAM	The results of the ROM/RAM test are displayed as "OK" or "NG" (No Good). If any NG is displayed, contact your dealer.
3	Serial loopback test (SENSOR, REMOTE-DAISY)	A test jumper is required for this test. (The result is blank if no jumper is connected.) The result of the loopback test is displayed as "OK" or no indication (means NG). (Field technician only)

No.	Items	Description
4	LCD Time	The accumulative operation time of LCD (maximum: 999999 hours) is displayed.
5	BRILL	The current setting of brilliance is displayed.
6	+5V line voltage	The voltage of the +5V line is displayed.
7	Program version (STARTER, BOOTER, MAIN)	Each program number and its program version numbers are displayed.
8	Program version (REMOTE (RD-501), DIMMER (RD-502))	

4. Press each key for RD-50, RD-501 or RD-502 one by one. A key's on-screen location turns red if the key is normal. When you press the key again, red changes to white.
5. Press the **MENU/ESC** key three times to escape from the test.
6. Press the **DISP** key to close the menu.

3.4 LCD Test

1. Press the **MENU/ESC** key to open the menu.
2. Press **▲** or **▼** key to select [TESTS] and press the **ENT** key.
3. Press **▲** or **▼** key to select [LCD TEST] and press the **ENT** key.
4. Press the **ENT** (or **DISP**, **DAY/NT**) key repeatedly. The screen changes as follows.

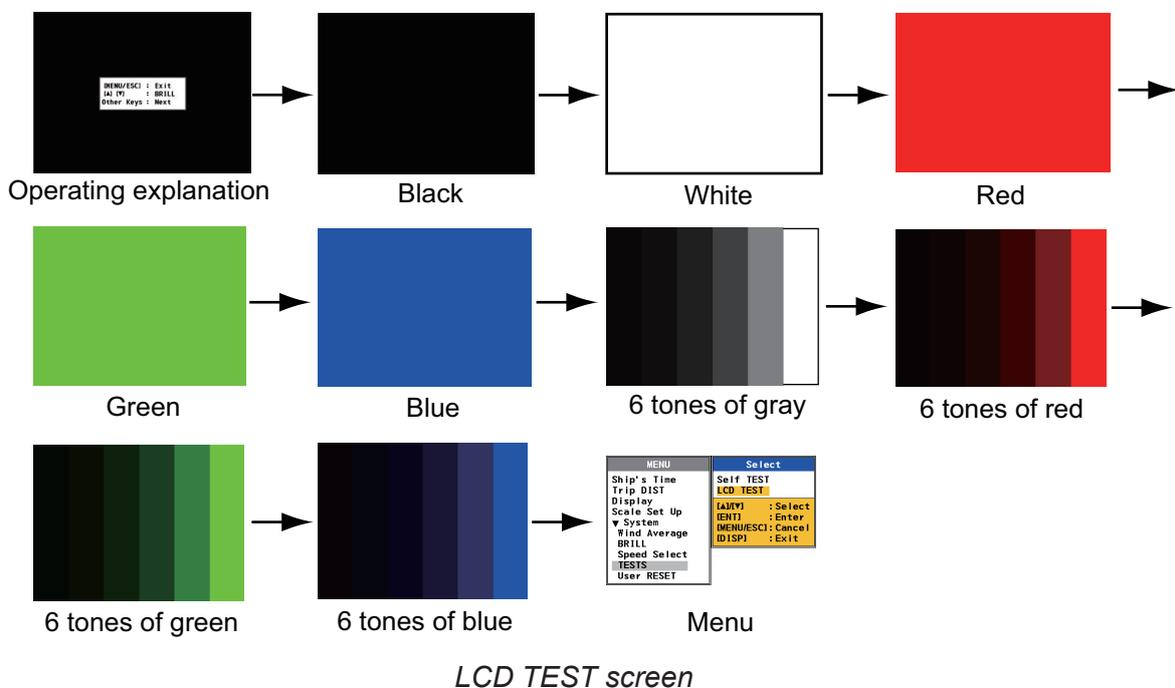

5. Press the **DISP** key to close the menu.
 - Note 1:** You can cancel the test any time when you press the **MENU/ESC** key. The menu screen appears.
 - Note 2:** You can adjust the display brilliance with **▲** or **▼** key during the test.

3.5 How to Reset the User Settings

You can restore all settings except setting in the [Trip DIST] menu.

1. Press the **MENU/ESC** key to open the menu.
2. Press **▲** or **▼** key to select [User RESET] and press the **ENT** key.

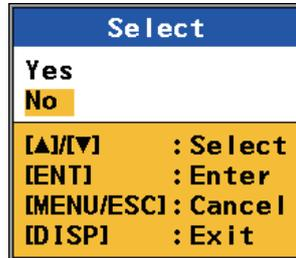

Use RESET options

3. Press **▲** key to select [Yes] and press the **ENT** key. The confirmation message appears.

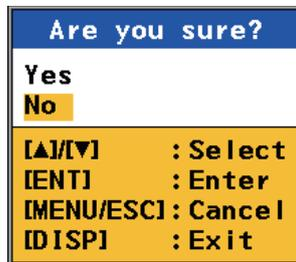

Confirmation options

4. Press **▲** key to select [Yes] and press the **ENT** key. The equipment restarts with the default settings.

3.6 Simulation Mode

A simulation mode, which shows internally generated navigation data, is provided to acquaint you with the features of the RD-50. "SIM" appears on the screen when the simulation mode is turned on.

1. While you hold down the **DISP** key, press the **PWR** key to turn on the power.

UNIT Name	: RD-50
Serial No	: 6408-XXXX
PWB No	: 26P0006-33
Remote Dimmer	: Main
Depth Select	: Auto
Depth Position	: Auto
L/L Digit	: 4digit
Without Checksum	: Disable
I/O Port	
Port1	: 4800
SIO Monitor	
Sensor Out	: ON
Device Mode	: Normal
LCD RESET	
SIM	: OFF
Service RESET	
[▲]/[▼] : Select	
[ENT] : Enter	

XXXX: Serial number
XX: Program version number

Service menu

2. Press **▲** or **▼** key to select [SIM] and press the **ENT** key.

Select	
ON	
OFF	
[▲]/[▼]	: Select
[ENT]	: Enter
[MENU/ESC]	: Cancel

SIM options

3. Press **▲** or **▼** key to select [ON] and press the **ENT** key.
4. Press the **PWR** key to turn off the power.
5. Press the **PWR** key again to turn on the power. The simulation mode starts.

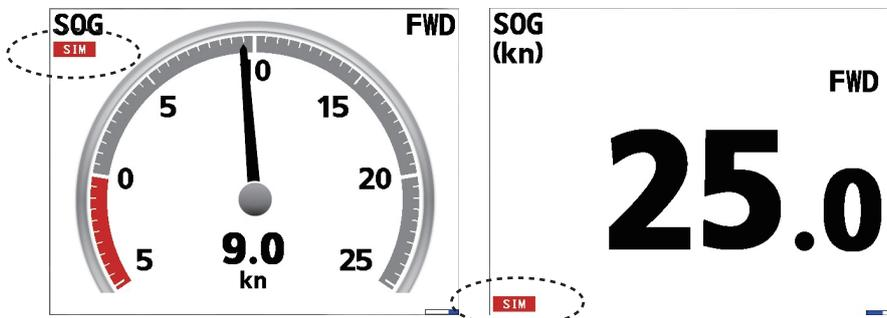

Examples of simulation screen

6. To stop the simulation mode, press the **PWR** key to turn off the power. Do step 1 to re-apply the power. Whenever you open the service menu, the [SIM] menu is set to [OFF].
7. Press the **PWR** key to turn off the power.

3.7 Parts Location and Parts List

Parts Location

RD-50

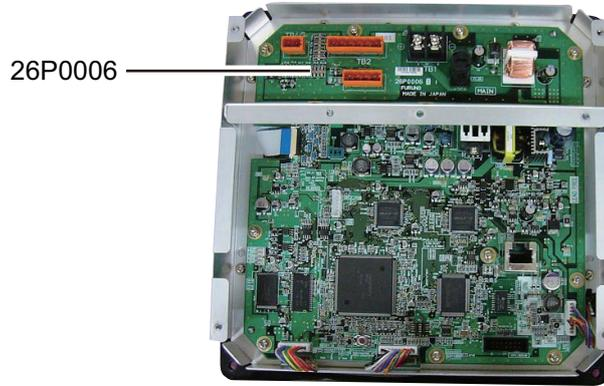

Rear cover opened



26P0006 board removed

RD-501/502

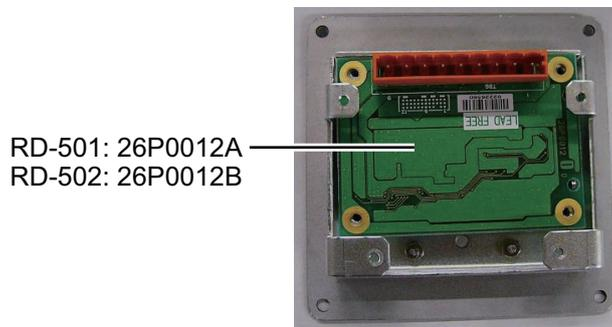

Cover opened

Parts List

ELECTRICAL PARTS	
Model	RD-50
Unit	Remote display RD-50
PRINTED CIRCUIT BOARD	Code No.
26P0006, MAIN	001-092-250
26P0007, PNL	001-092-230
LCD	Code No.
NL6448BC26-22F	000-171-704-10

ELECTRICAL PARTS	
Model	RD-501
Unit	Remote controller RD-501
PRINTED CIRCUIT BOARD	Code No.
26P0012A, RMT	001-092-320

ELECTRICAL PARTS	
Model	RD-502
Unit	Dimmer controller RD-502
PRINTED CIRCUIT BOARD	Code No.
26P0012B, RMT	001-092-370

4. INSTALLATION

4.1 Equipment List

Standard supply

Name	Type	Code No.	Qty	Remarks
Remote Display	RD-50	-	1	
Installation Materials	CP26-01501*	-	1	
Accessories	FP26-00601*	-	1	
Spare Parts	SP26-00101	001-076-380-00	1	Fuse (2 pcs., FGMB 125V 2A PBF, 000-157-479-10)

Optional supply

Name	Type	Code No.	Remarks
Remote Controller	RD-501	-	CP26-01101*
Dimmer Controller	RD-502	-	CP26-01201*
Hanger	OP26-8	000-016-313-00	
Waterproof Box	DS-605	000-016-398-00	

*: See the Packing lists.

4.2 Installation of Remote Display

Mounting considerations

The remote display can be installed on a desktop, on the underside of a table, or flush mounted in a panel. When you select a mounting location, keep in mind the following points:

- The nominal viewing distance for the remote display is 1 m. Select a suitable mounting location considering that distance.
- Locate the remote display away from exhaust pipes and vents.
- Select an installation location that is well ventilated.
- Locate the remote display where shock and vibration are minimal.
- Locate the remote display away from equipment which generates the electromagnetic fields like a motor or generator.
- Allow enough maintenance space at the sides and rear of the remote display and leave enough slack in cables to facilitate maintenance and servicing.
- Observe the compass safe distances (see page ii) to prevent the interference to a magnetic compass.

4. INSTALLATION

Flush mounting

See the outline drawing in the back of this manual.

1. Make a cutout in the mounting location as shown in the illustration below.
2. Make four pilot holes for self-tapping screws (diameter: 5 mm) in the location indicated in the illustration below.
3. Insert the sponge to the remote display from the rear side.
4. Set the remote display to the cutout and fasten the remote display with four self-tapping screws (5x20).
5. Set a cosmetic cap to each fixing hole on the front panel. (See "How to set the cosmetic cap" on page 4-4.)

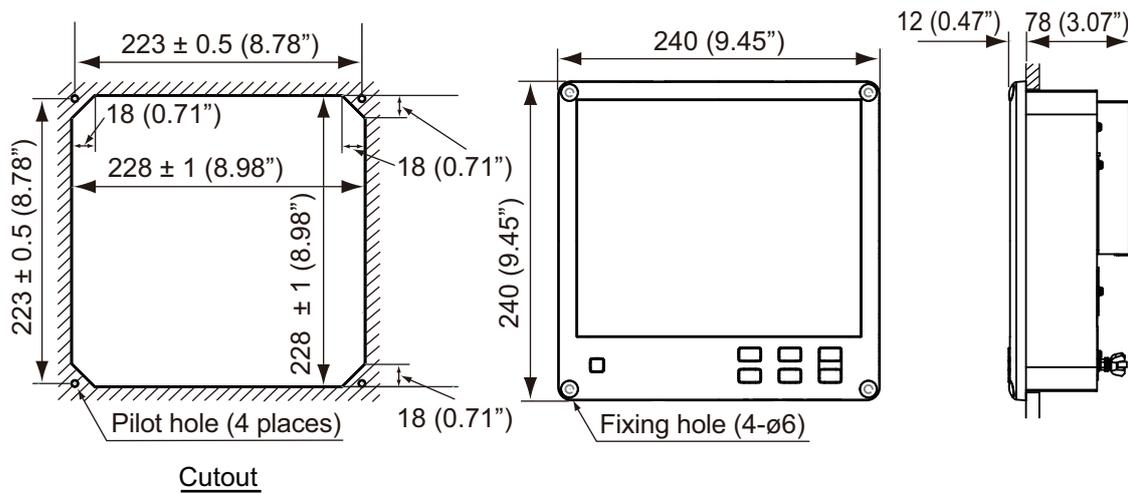

Note: When you fasten the remote display to the cutout after you connect the cable to the remote display, first connect the cables referring to section 4.5.

Desktop or table underside mounting

The remote display can be mounted on a desktop or on the underside of a table using the optional hanger. See the outline drawing for details.

Hanger assembly (Type: OP26-8, Code No.: 000-016-313-00)

Name	Type	Code No.	Qty
Self-tapping screw	5x20	000-171-997-10	4
Binding head screw	M5x12	000-171-999-10	4
Hanger assy.	OP26-8-1	001-081-920-00	1

1. Remove the hanger mounting plate from the hanger assembly.
2. Fasten the hanger mounting plate to the remote display from the left side and right side with four binding head screws (M5x12).

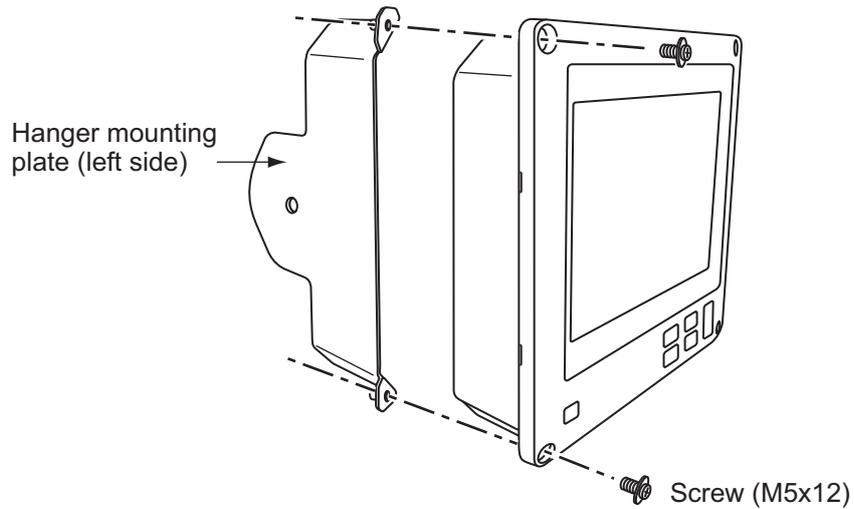

3. Make a four pilot holes for self-tapping screws (5x20) in the mounting location.
4. Fix the hanger to the mounting location with four self-tapping screws (5x20).
5. Insert a washer to each knob (right and left) and fix the washer to the remote display loosely.
6. Set the remote display to the hanger.
7. Tighten the knobs to fasten the hanger to the remote display.
8. Set a cosmetic cap to each fixing hole on the front panel. (See the following "How to set the cosmetic cap".)

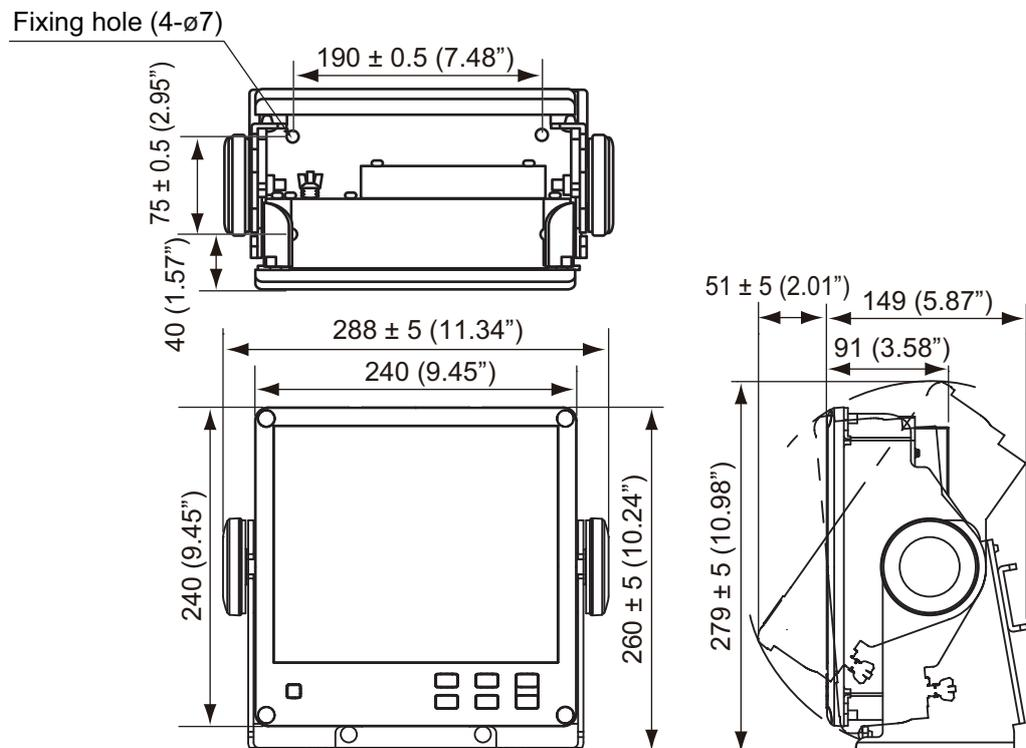

How to set the cosmetic cap

Set a cosmetic cap to each fixing hole on the front panel in reference to the following illustration.

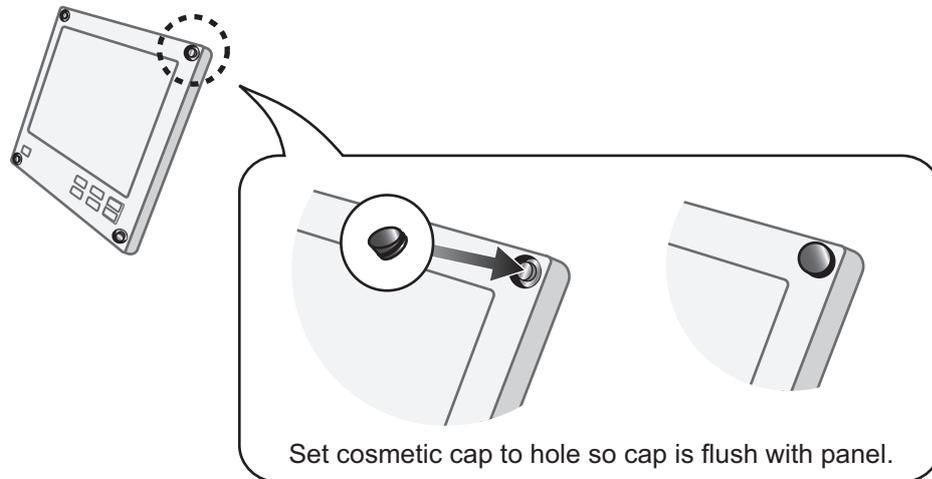

4.3 Installation of Remote Controller and Dimmer Controller

The optional remote controller RD-501 and dimmer controller RD-502 can be flush mounted in a panel. The size and the mounting procedure are shared by RD-501 and RD-502. For the mounting location, refer to the mounting considerations for the remote display in section 4.2.

Flush mounting

1. Make a cutout in the mounting location (88 mm (width) x 76 mm (height)).
2. Make four holes of $\phi 4$ in the locations indicated in the illustration below.
3. Set the remote controller or dimmer controller to the cutout. Insert four binding head screws (M3x12) from the front side then fasten the unit with four sets of flat washers, spring washers and hexagonal nuts from the rear side.

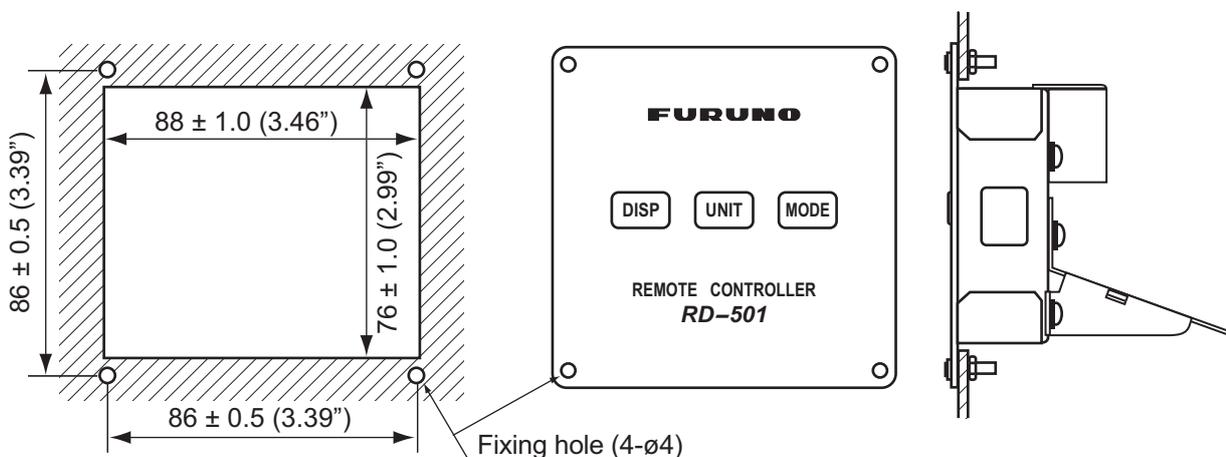

Note: When you fasten the remote controller or dimmer controller to the cutout after you connect the cable to the remote controller or dimmer controller, first connect the cables referring to section 4.5.

4.4 Installation of Remote Display with DS-605 (Waterproof Box)

For installation of the remote display on the wings of the bridge, use the optional waterproof box DS-605. Fix the DS-605 on the bulkhead and set the remote display therein.

Installation materials for DS-605 (Type: CP66-01731, Code No.: 001-082-660-00)

Name	Type	Code No.	Qty	Remarks
Seal washer	03-001-3002-0 ROHS	300-130-020-10	4	
Gasket	26-003-1605	100-355-310-10	1	
Washer	26-003-1607	100-355-320-10	2	
Cable gland washer	For JIS F8801 25C	000-172-238-10	2	Not for the RD-50 but for the DS-60.
Cable gland inner gasket	For JIS F8801 25C	000-171-892-10	1	
Silicon rubber	S-8400W Aluminum tube 50G	000-158-483-10	1	
Binding Head Screw	M5×12 SUS304	000-171-999-10	4	

Installation materials for RD-50 (Type: CP26-01501, Code No.: 001-081-900-00)

Name	Type	Code No.	Qty	Remarks
Cable Clamp (2)	06-003-1528-0	100-355-110-10	1	
Flush Mount Sponge	26-003-1532-2	100-355-202-10	1	Not used for DS-605.
Tapping Screw	5x20 SUS304	000-171-997-10	4	

Mounting considerations

The DS-605 has waterproofing protection of IP56. When you select a mounting location for the waterproof box, keep in mind the following points.

- Keep the unit away from electromagnetic field-generating equipment like motors and generators.
- For maintenance and checking purposes, leave enough space at the sides of the unit and leave slack in cables. Refer to page D-5.
- A magnetic compass will be affected if the waterproof box is too close to the magnetic compass. Observe the compass safe distances (see page ii) to prevent interference to a magnetic compass.

Mounting procedure

Note: Mount the DS-605 on the bulkhead so the cable glands and the drain hole are down.

1. Fix the DS-605 on the wings of the bridge.
 - 1) Insert the seal washer (03-001-3002-0 ROHS) to four fixing holes.

4. INSTALLATION

- 2) Fix the DS-605 with four M10 bolts (dockyard supply).

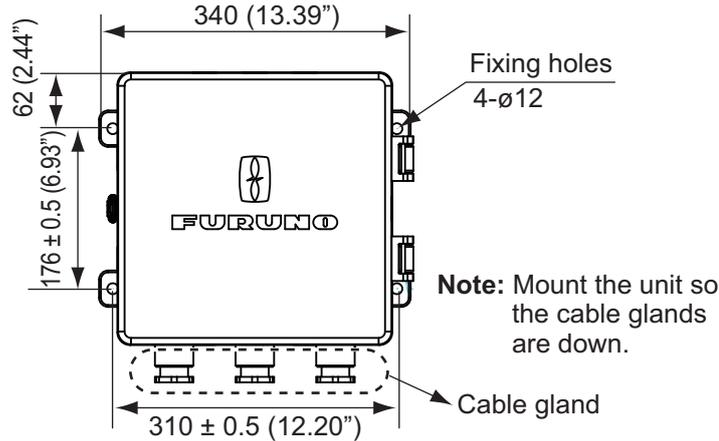

- 3) Apply silicon rubber to M10 bolts as shown below.

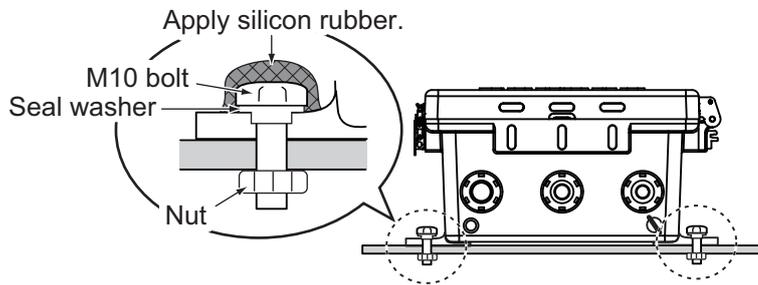

2. Connect the power cable and the sensor signal cable to the RD-50 through the cable glands for the DS-605.

- 1) Process the power cable and the sensor signal cable referring to the illustration below.

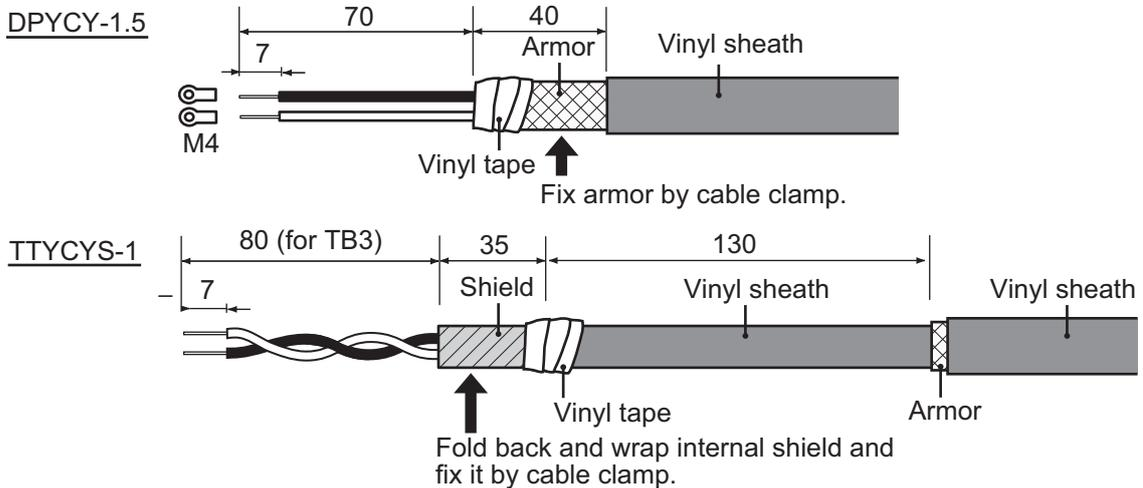

- 2) **For the power cable**, unfasten the clamping gland and remove washers and gasket from the DS-605. Discard the washers and gasket. Pass the clamping gland, washer (26-003-1607), gasket (26-003-1605) and washer (supplied as installation materials) onto the power cable, in that order.

Note: Do not use the washers and gasket which are removed from the cable gland of the DS-605.

- 3) **For the sensor signal cable**, unfasten the clamping gland and remove washers and gasket from the DS-605. Pass the clamping gland, washer, gasket and washer onto the the sensor signal cable, in that order.

- 4) Pass each cable through assigned cable gland as shown in the right figure.
- 5) Open the front cover of the DS-605 and connect the ground wire attached inside the DS-605 to the ground terminal on the rear of the RD-50.
- 6) Connect the cables to the RD-50. Refer to section 4.5.

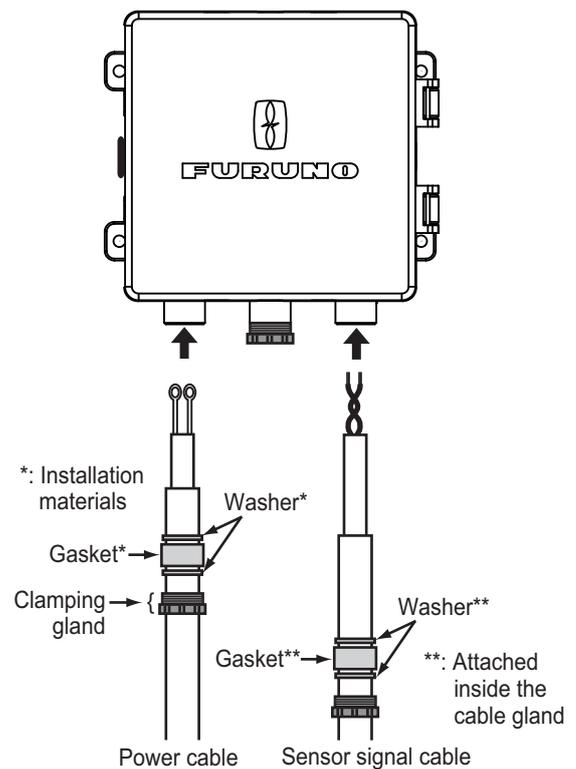

3. Remove each binding head screw from four corners of the DS-605 and set the RD-50 to the DS-605. These screws removed can be discarded.
4. Apply silicon grease to the binding head screws included in CP66-01731 and fix the RD-50 to the DS-605 with four binding head screws.
5. Tighten the clamping glands to fix the cables.
6. Apply the putty to the cable glands for waterproofing.
7. Connect the ground terminal for the DS-605 to the ground terminal on the hull with the IV-1.25 sq wire.

How to change orientation of the front cover of DS-605

The front cover of the DS-605 can be oriented up, down, right or left. To change the orientation of the front cover, do the following:

1. Remove eight screws from two hinges.
2. Remove two screws from the latch.
3. Remove the hinges and the hidden lids for fixing hole of latch in consideration of the opening direction.

The hidden lids for fixing hole of latch are taped on each side.

4. INSTALLATION

- Orient the front cover as desired and fix the hinges and latch.

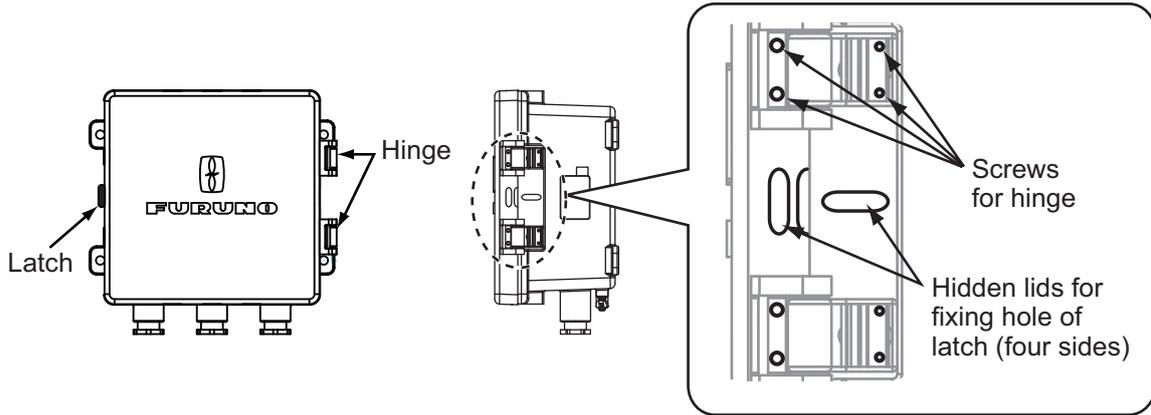

Note: Set the front cover so the FURUNO logo on the cover is right side up. The drain hole should be down.

4.5 Wiring

Interconnection

Refer to the interconnection diagram (page S-1) to connect cables.

Single remote display

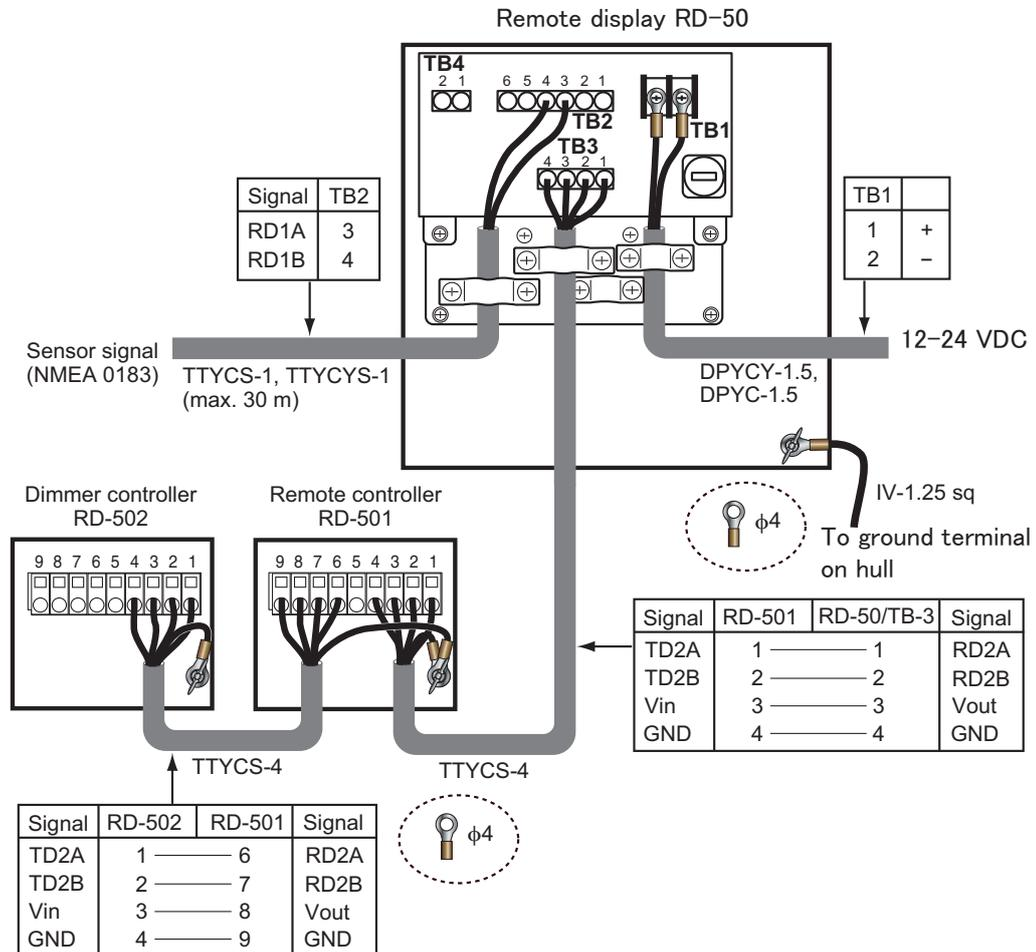

Example of multiple remote displays (daisy chain connection)

Pattern 1: Sensor signal and dimmer are commonly used. A total of 10 remote display units can be connected in a daisy chain. A maximum of nine sub remote display units can be connected.

RD-50 daisy chain

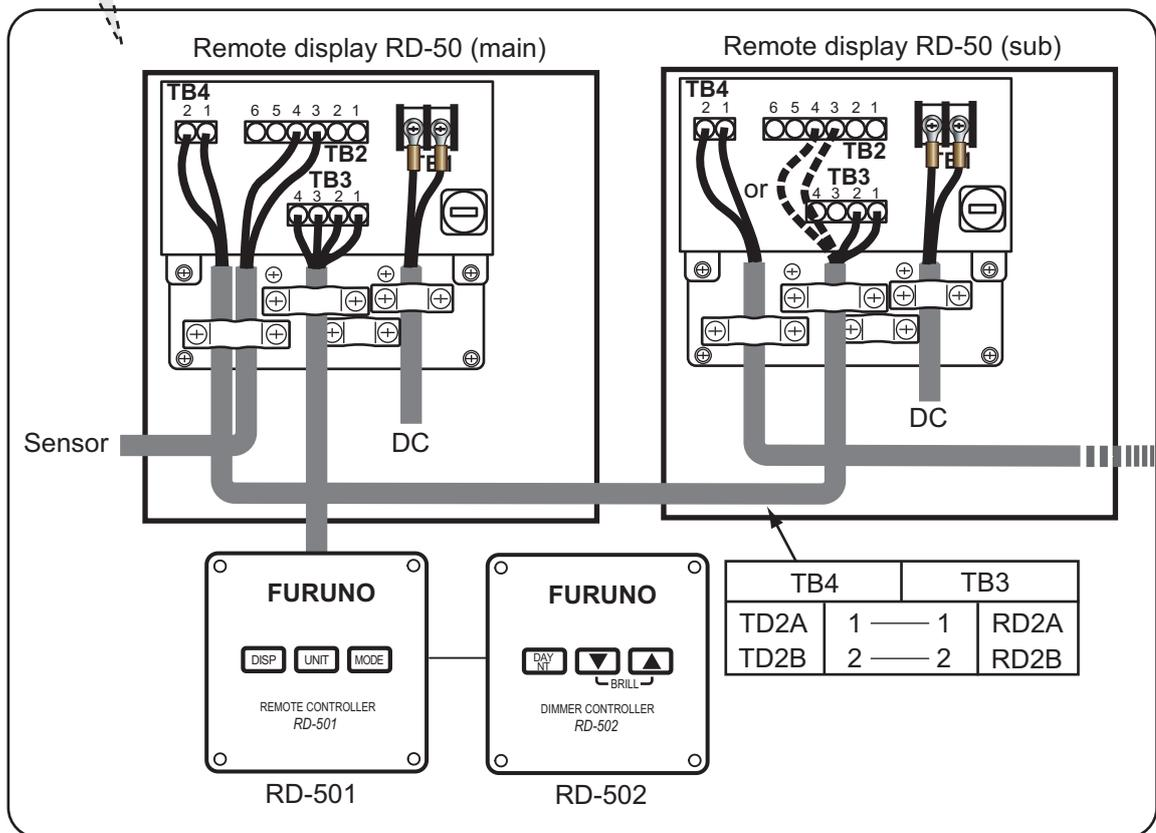
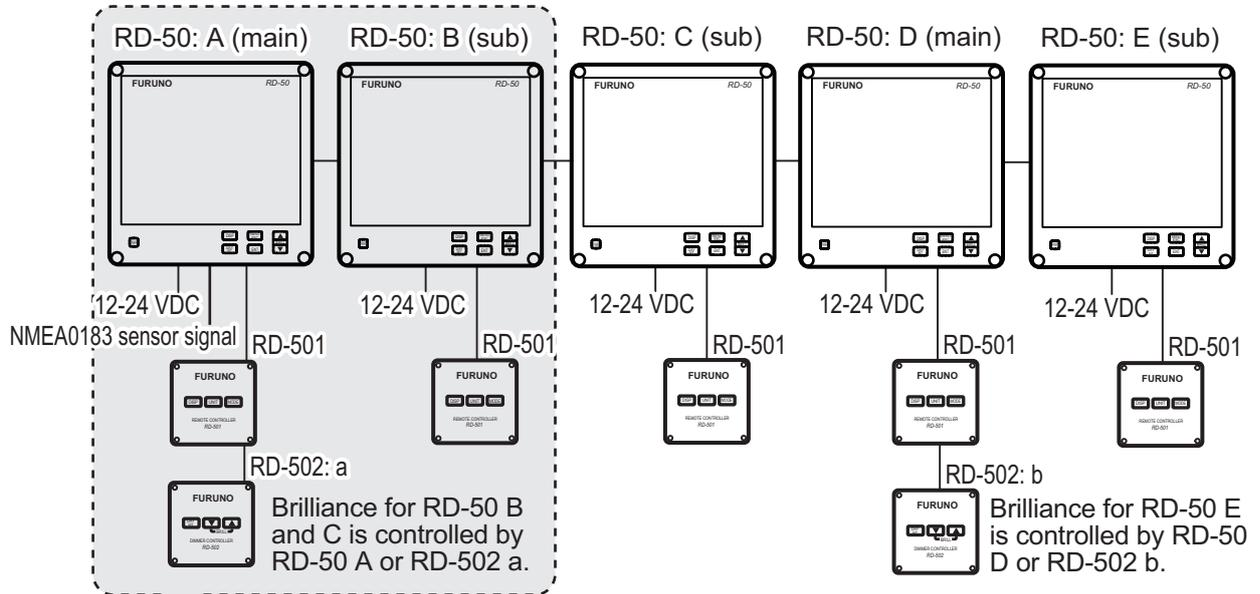

4. INSTALLATION

RD-50 and RD-20 combination daisy chain

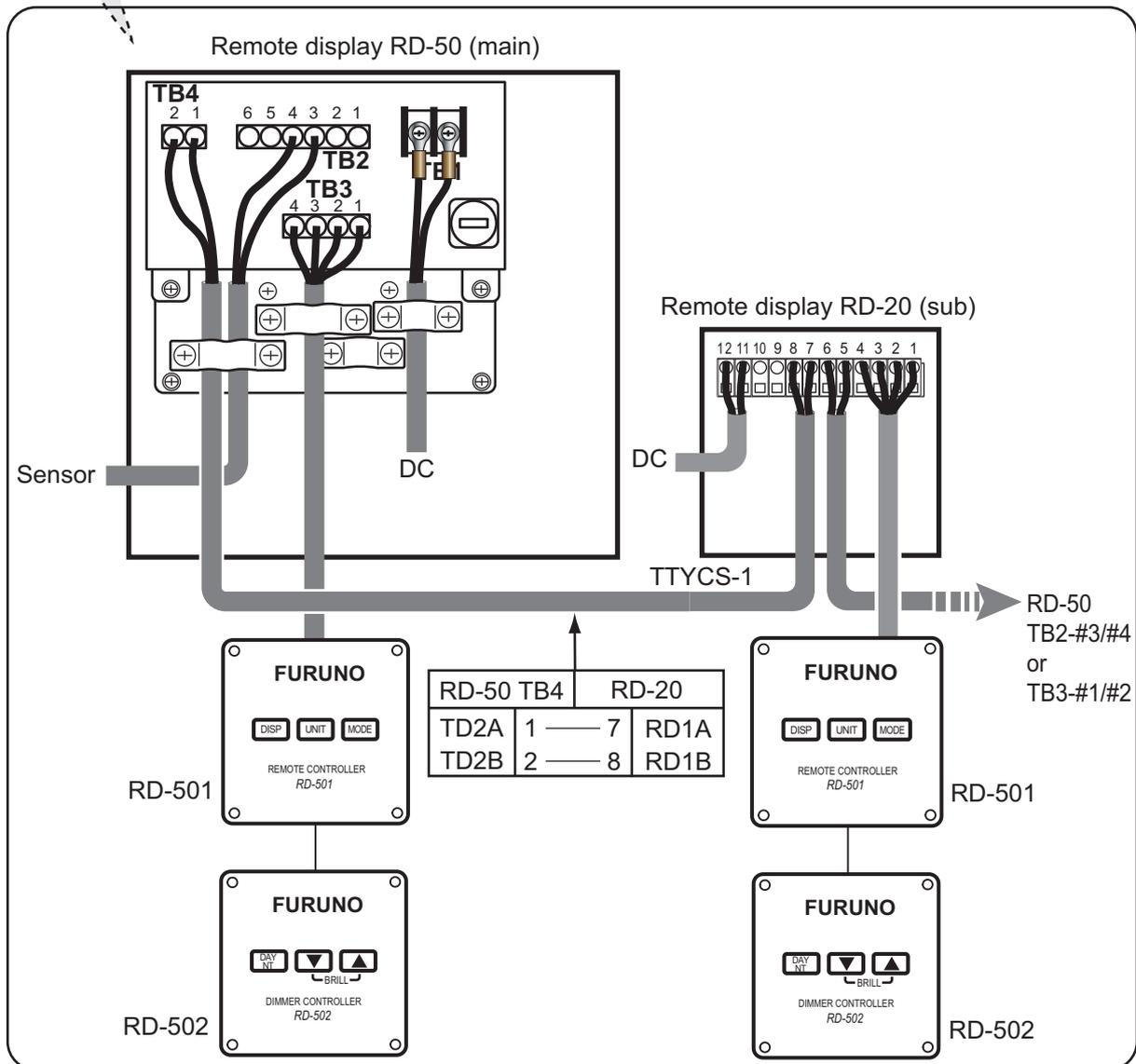
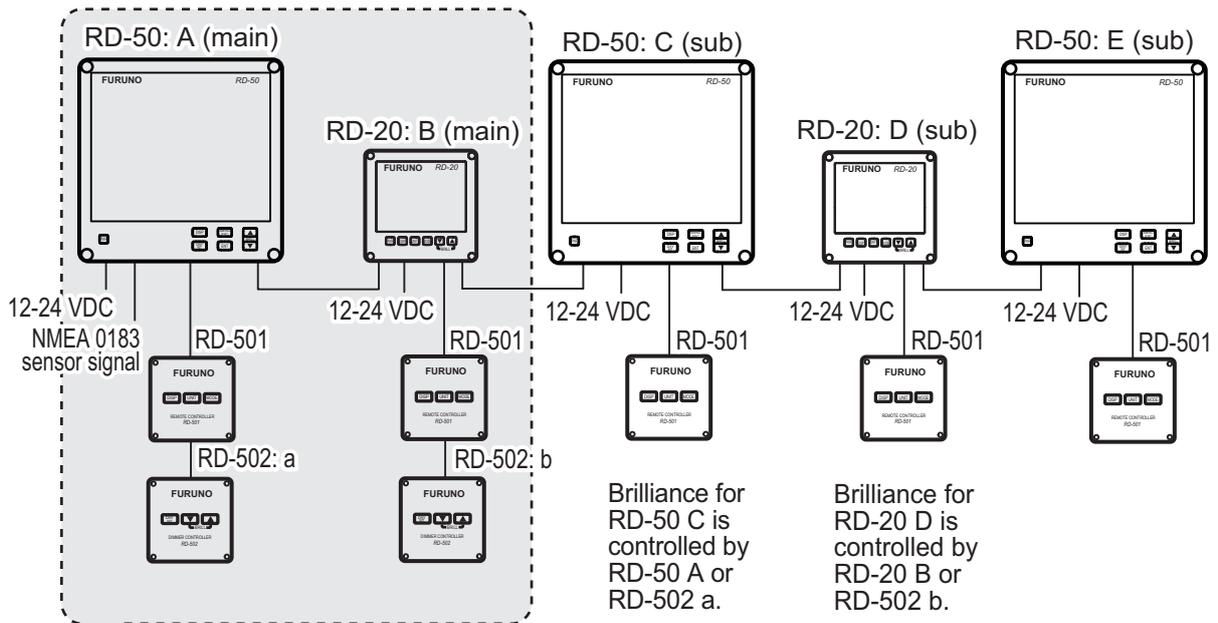

Pattern 2: Dimmer controller is commonly used. A total of 10 RD-50s can be connected in a daisy chain. A maximum of nine sub RD-50s can be connected.

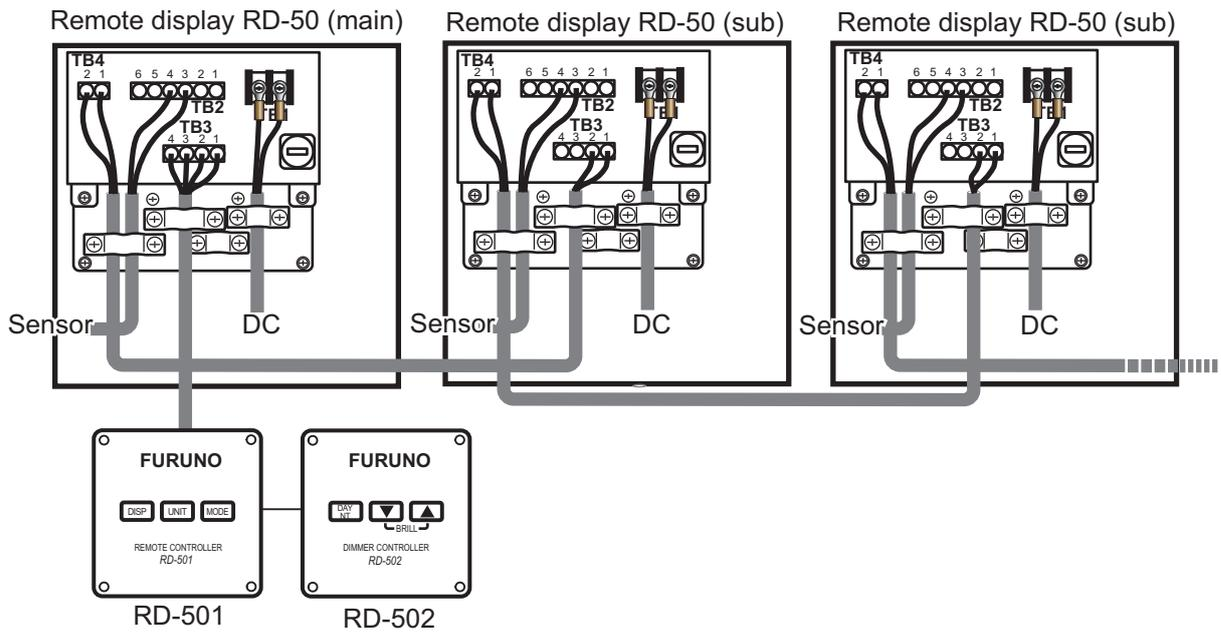

Connection of each unit

Process each cable referring to the illustrations below and on the next page.

Fabrication of RD-50 power cable DPYC-1.5 (indoor type)

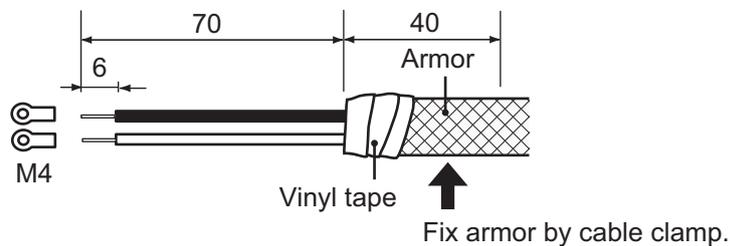

Fabrication of sensor signal cable TTYCS-1 (indoor type) / TTYCS-4

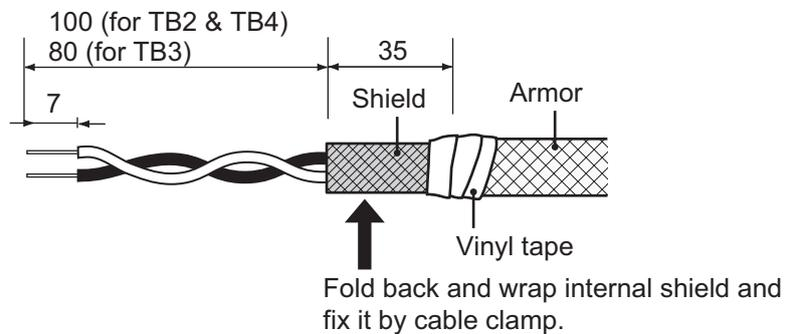

4. INSTALLATION

Fabrication of cable TTYCS-4 for RD-501/502, coming from RD-50

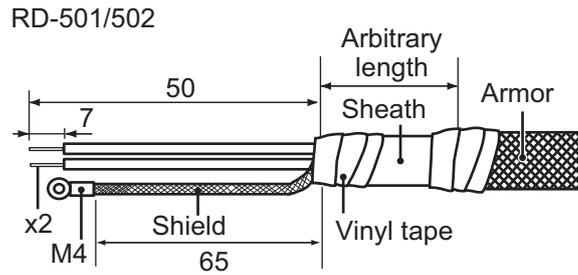

Fabrication of cable TTYCS-4 between RD-501 and RD-502

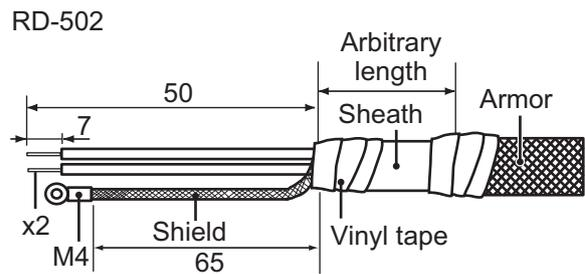
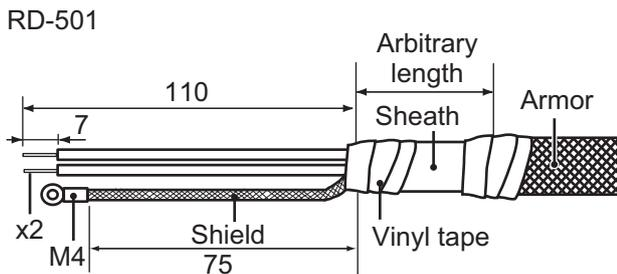

Connection of power cable

Connect the power cable to the TB1. Fix the armor of the cable by the cable clamp. See the illustration below.

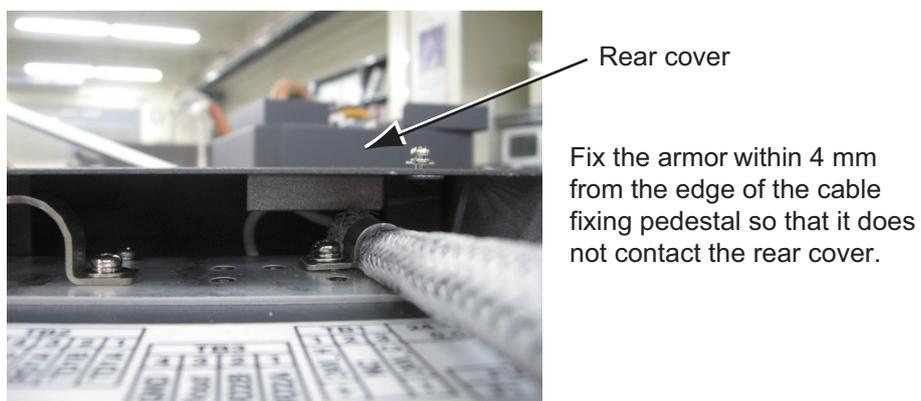
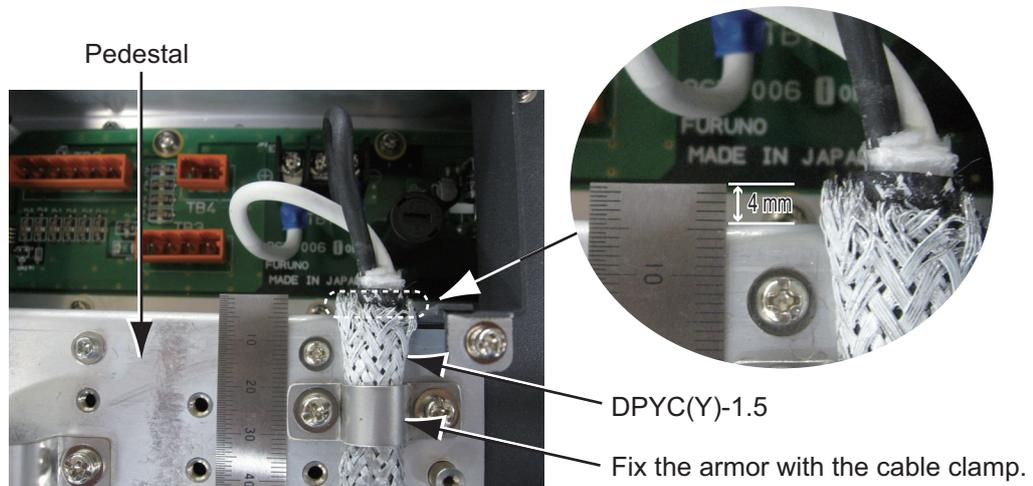

Connection of WAGO connector

Remove the WAGO connector from each unit and connect each cable core to the WAGO connector. See the interconnection diagram (page S-1). The terminal opener is attached inside the remote display at the location shown in the illustration below.

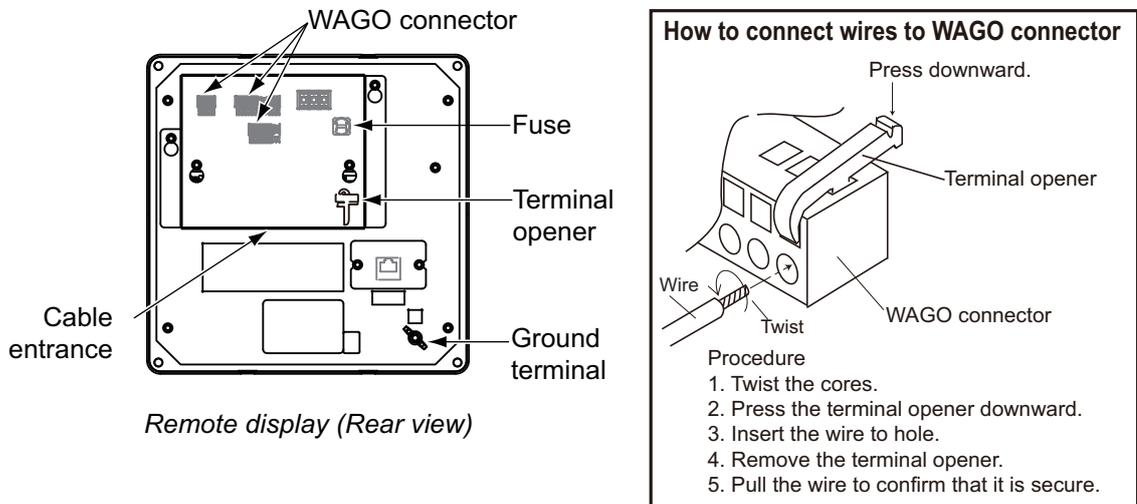

4.6 Adjustments

After wiring all units, initialize each remote display as follows:

1. While you hold down the **DISP** key, press the **PWR** key to turn on the power.

UNIT Name	: RD-50
Serial No	: 6408-XXXX
PWB No	: 26P0006-33
Remote Dimmer	: Main
Depth Select	: Auto
Depth Position	: Auto
L/L Digit	: 4digit
Without Checksum	: Disable
I/O Port	
Port1	: 4800
SIO Monitor	
Sensor Out	: ON
Device Mode	: Normal
LCD RESET	
SIM	: OFF
Service RESET	
▲/▼: Select	
[ENT]: Enter	

XXXX: Serial number
XX: Program version number

Service menu

2. Press ▲ or ▼ key to select a menu item and press the **ENT** key.
3. Press ▲ or ▼ key to select an option and press the **ENT** key.
4. Repeat steps 2 and 3 to set the menu items desired.
5. Press the **PWR** key to close the service menu and turn off the power.

4. INSTALLATION

Service menu items

Menu	Description	Default
UNIT Name	For serviceman.	
Serial No		
PWB No		
Remote Dimmer	<ul style="list-style-type: none"> • [Main]: Set the unit which is connected to the dimmer controller in the daisy chain connection as the main unit. • [Sub]: Set the unit which is not connected to the dimmer controller in the daisy chain connection as a sub unit. 	[Main]
Depth Select	Select the input sentence for depth. <ul style="list-style-type: none"> • [Auto]: Switch the sentence automatically according to the priority. The highest priority data is [Keel (DBK)] and the lowest is [Surface (DBS)]. • [Keel (DBK)]: Depth below keel • [Transducer (DBT)]: Depth below transducer • [Surface (DBS)]: Depth below surface 	[Auto]
Depth Position	Select the mounting location of the transducer. <ul style="list-style-type: none"> • [Single]: For one transducer • [FORE]: For transducer mounted at fore position • [AFT]: For transducer mounted at aft position • [Auto]: The depth position setting of the echo sounder (FE-800) is used when the FE-800 is connected. 	[Single]
L/L Digit	Select the number of digits to show after the decimal point for minute of latitude and longitude from [3digit] or [4digit].	[4digit]
Without Checksum	<ul style="list-style-type: none"> • [Enable]: Receive NMEA 0183 sentences with and without checksums. • [Disable]: Do not receive NMEA 0183 sentences that do not have checksums. 	[Disable]
I/O Port	<ul style="list-style-type: none"> • [Port1]: Select baud rate setting from [4800] or [38400] according to the equipment connected. • [SIO Monitor]: Monitor the SIO input signal. For serviceman. 	[4800]
Sensor Out	<ul style="list-style-type: none"> • [ON]: Share sensor signal, dimmer controller and time data in the daisy chain. Use for pattern 1 daisy chain (see pages 4-10 and 4-11). • [OFF]: Share dimmer controller and time data in the daisy chain. Use for pattern 2 daisy chain (see page 4-11). 	[ON]
Device Mode	Select if the RD-50 is used as ROTI display. <ul style="list-style-type: none"> • [Normal]: For other than ROTI • [ROTI]: For ROTI, displays only ROT data. 	[Normal]
LCD RESET	For serviceman.	
SIM	Turn the simulation mode on or off.	[OFF]
Service RESET	For serviceman.	

4.7 JIS Cable Guide

Cables listed in the manual are usually shown as Japanese Industrial Standard (JIS). Use the following guide to locate an equivalent cable locally.

JIS cable names may have up to 6 alphabetical characters, followed by a dash and a numerical value (example: DPYC-2.5).

For core types D and T, the numerical designation indicates the *cross-sectional Area (mm²)* of the core wire(s) in the cable.

For core types M and TT, the numerical designation indicates the *number of core wires* in the cable.

1. Core Type

- D: Double core power line
- T: Triple core power line
- M: Multi core
- TT: Twisted pair communications (1Q=quad cable)

2. Insulation Type

- P: Ethylene Propylene Rubber

3. Sheath Type

- Y: PVC (Vinyl)

4. Armor Type

- C: Steel

5. Sheath Type

- Y: Anticorrosive vinyl sheath

6. Shielding Type

- S: All cores in one sheath
- S: Individually sheathed cores
- SLA: All cores in one shield, plastic tape w/aluminum tape
- SLA: Individually shielded cores, plastic tape w/aluminum tape



DPYC



TPYC

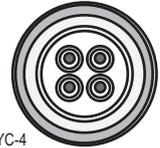

MPYC-4

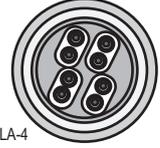

TTYCSLA-4

EX: ^{1 2 3 4 5 6} TTYCYSLA - 4
 Designation type # of twisted pairs

EX: ^{1 2 3 4} MPYC - 4
 Designation type # of cores

The following reference table lists gives the measurements of JIS cables commonly used with Furuno products:

Type	Area	Core Diameter	Cable Diameter	Type	Area	Core Diameter	Cable Diameter
DPYC-1.5	1.5mm ²	1.56mm	11.7mm	TTYCS-1	0.75mm ²	1.11mm	10.1mm
DPYC-2.5	2.5mm ²	2.01mm	12.8mm	TTYCS-1T	0.75mm ²	1.11mm	10.6mm
DPYC-4	4.0mm ²	2.55mm	13.9mm	TTYCS-1Q	0.75mm ²	1.11mm	11.3mm
DPYC-6	6.0mm ²	3.12mm	15.2mm	TTYCS-4	0.75mm ²	1.11mm	16.3mm
DPYC-10	10.0mm ²	4.05mm	17.1mm	TTYCSLA-1	0.75mm ²	1.11mm	9.4mm
DPYCY-1.5	1.5mm ²	1.56mm	13.7mm	TTYCSLA-1T	0.75mm ²	1.11mm	10.1mm
DPYCY-2.5	2.5mm ²	2.01mm	14.8mm	TTYCSLA-1Q	0.75mm ²	1.11mm	10.8mm
DPYCY-4	4.0mm ²	2.55mm	15.9mm	TTYCSLA-4	0.75mm ²	1.11mm	15.7mm
MPYC-2	1.0mm ²	1.29mm	10.0mm	TTYCY-1	0.75mm ²	1.11mm	11.0mm
MPYC-4	1.0mm ²	1.29mm	11.2mm	TTYCY-1T	0.75mm ²	1.11mm	11.7mm
MPYCSLA-4	1.0mm ²	1.29mm	11.4mm	TTYCY-1Q	0.75mm ²	1.11mm	12.6mm
MPYC-7	1.0mm ²	1.29mm	13.2mm	TTYCY-4	0.75mm ²	1.11mm	17.7mm
MPYC-12	1.0mm ²	1.29mm	16.8mm	TTYCY-4S	0.75mm ²	1.11mm	21.1mm
TPYC-1.5	1.5mm ²	1.56mm	12.5mm	TTYCY-4SLA	0.75mm ²	1.11mm	19.5mm
TPYC-2.5	2.5mm ²	2.01mm	13.5mm	TTYCYS-1	0.75mm ²	1.11mm	12.1mm
TPYC-4	4.0mm ²	2.55mm	14.7mm	TTYCYS-4	0.75mm ²	1.11mm	18.5mm
TPYCY-1.5	1.5mm ²	1.56mm	14.5mm	TTYCYSLA-1	0.75mm ²	1.11mm	11.2mm
TPYCY-2.5	2.5mm ²	2.01mm	15.5mm	TTYCYSLA-4	0.75mm ²	1.11mm	17.9mm
TPYCY-4	4.0mm ²	2.55mm	16.9mm				

4. INSTALLATION

This page is intentionally left blank.

APPENDIX 1 MENU TREE

MENU key

Bold: Default setting

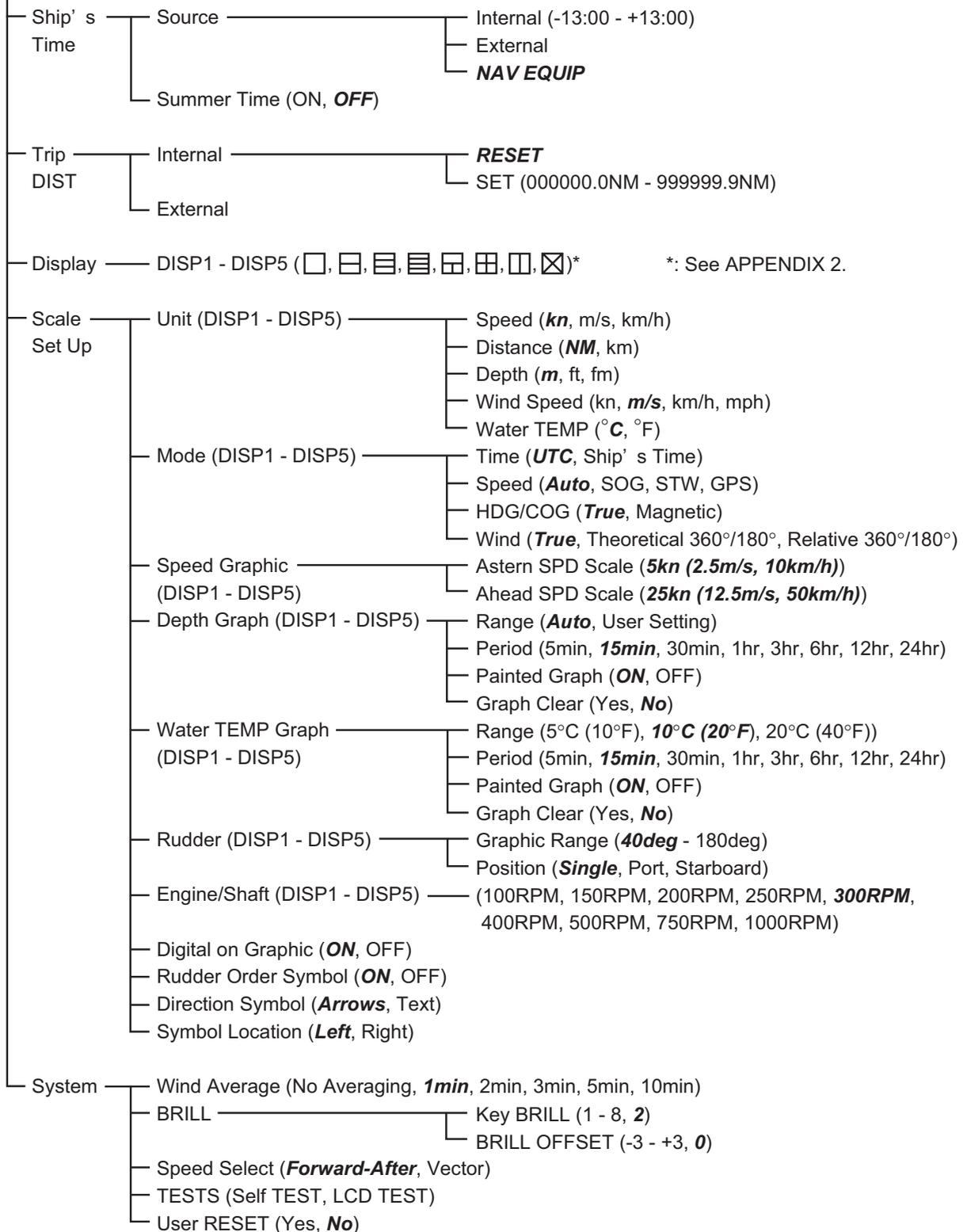

APPENDIX 2 SCREEN DIVISION

The screen can be divided as shown below in the [Display] menu.

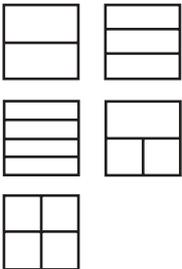
Screen division	Display form	Display item
	Graphic	Time, Speed, HDG/COG, HDG, ROT, Wind, Rudder, Engine, Shaft, Propeller Pitch
	Digital	Time, POSN, HDG/Speed 3 axis, Speed 3 axis, Speed 2 axis, Speed 1 axis, HDG, COG, WPT, Trip DIST, Total DIST, Depth, ROT, Wind Speed, Wind Direction, Rudder Angle, Rudder Angle Order, Water TEMP, Engine, Shaft, Propeller Pitch, Depth F/A HOR-Split* ² , Depth F/A VER-Split* ² , Depth A/F VER-Split* ²
	Graph	Depth Graph, Water TEMP Graph, Depth F/A Graph* ² , Depth A/F Graph* ²
	Digital	Time, POSN, Speed 1 axis, HDG, COG, WPT, Trip DIST, Total DIST, Depth, ROT, Wind Speed, Wind Direction, Rudder Angle, Rudder Angle Order, Water TEMP, Engine, Shaft, Propeller Pitch
	Digital	Time, POSN, Speed 1 axis, HDG, COG, WPT, Trip DIST, Total DIST, Depth, ROT, Wind Speed, Wind Direction, Rudder Angle, Rudder Angle Order, Water TEMP, Engine, Shaft, Propeller Pitch
	Graph	Depth Graph, Water TEMP Graph
 *1	-	-

*1: Can not select for the [DISP1] screen.

*2: Where [Depth Position] is set to [Auto].

APPENDIX 3 LIST OF TERMS

The following table shows the terms used in the RD-50.

Term	Meaning
A	Automatic
AFT	After
AH	Ahead
ANGLE	Angle
AS	Astern
BRILL	Brilliance
COG	Course Over the Ground
DAY	Day
DBK	Depth Below Keel
DBS	Depth Below Surface
DBT	Depth Below Transducer
deg	degree
Depth F/A	Depth FORE/AFT
Depth A/F	Depth AFT/FORE
DIR	Direction
DISP	Display
DIST	Distance
DPTH	Depth
ENGINE	Engine
ENT	Enter
EQUIP	Equipment
ESC	Escape
fm	fathom
ft	feet
FWD	Forward
GPS	Global Positioning System
HDG	Heading
HOR-Split	Horizontal-Split
hr	Hour
I/O	Input/Output
KEEL	Keel
km/h	Kilometer/hour
km	kilometer
kn	knot
LCD	Liquid Crystal Display
L/L	Latitude/Longitude
m	Meter
MAG	Magnetic: The bearing measured with magnetic north as the reference direction.
MAIN	Main
min	minute
mph	Miles per hour
m/s	Meter/second
NAV	Navigation

APPENDIX 3 LIST OF TERMS

Term	Meaning
NG	No Good
NM	Nautical Mile
No.	Number
NT	Night
ORDER	Rudder Angle Order
OVER	Over
PITCH	Pitch
P/PORT	Port/Port Side
POSN	Position
PROG	Program
PWB	Printed Writing Board
PWR	Power
R	Relative: Relative or apparent wind. The wind direction relative to the ship's bow and the wind speed relative to the moving vessel.
RAM	Random Access Memory
REMOTE	Remote
RESET	Reset
ROM	Read Only Memory
ROT	Rate of Turn
RPM	Revolutions Per Minute
RUDDER	Rudder
SENSOR	Sensor
SHAFT	Shaft
SIM	Simulation
SIO	Serial Input Output
S-OUT	Sensor Out
SPD	Speed
SOG	Speed Over the Ground
STW	Speed Through the Water
S/STBD	Starboard/Starboard Side
SUB	Sub
SURFACE	Surface
T	True. The bearing measured using true North as the reference direction and the wind speed as if the ship is stationary.
T	True. The bearing measured using true North as the reference direction.
TEMP	Temperature
TH	Theoretical. Theoretical or calculated wind. The wind direction relative to the ship's bow and the wind speed as if the ship is stationary.
TIME	Time
TOTAL	Total
TRANSDUCER	Transducer
UNIT	Unit
UTC	Universal Time Coordinated
VER-Split	Vertical-Split
WIND	Wind
WPT	Waypoint

APPENDIX 4 DIGITAL INTERFACE

Input/output sentences

BWC, BWR, DBK, DBS, DBT, DPT, GGA, GLL, GNS, HDG, HDM, HDT, HTC, HTD, MTW, MWD, MWV, RMB, RMC, ROT, RPM, RSA, THS, VBW, VHW, VLW, VTG, VWR, VWT, WPL, ZDA

Data reception

Data is received in serial asynchronous form in accordance with the standard referenced in IEC 61162-1.

The following parameters are used:

- Baud rate Input: 4800 bps, IEC 61162-1-2 Output: Same as above. Baud rate fixed at 38400 bps for RD-50.
- Data bits: 8 (D7 = 0), Parity: none, Stop bits: 1

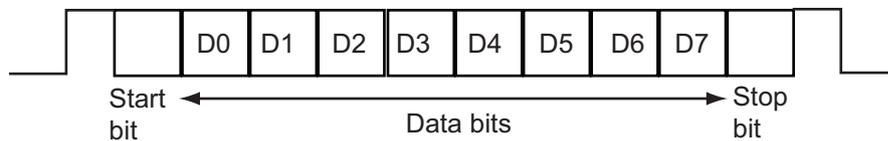

Data sentences: Input/output

BWC - Bearing and distance to waypoint

```
$ **BWC,hhmmss.ss,IIII.II, a,IIII.II,a,yyy.y,T, yyy.y,M,yyy.y,N,c--c,A,*hh<CR><LF>
```

1 2 3 4 5 6 7 8 9 10 11 12 13

1. UTC Time (unused)
2. Waypoint latitude (0.00000 to 9000.00000)
3. N/S
4. Waypoint longitude (0.00000 to 18000.00000)
5. E/W
6. Bearing, degrees true (unused)
7. Unit (unused)
8. Bearing, degrees magnetic (unused)
9. Unit (unused)
10. Distance, nautical miles (unused)
11. Unit (unused)
12. Waypoint ID (Max. 8 characters)
13. Mode Indicator (A=Autonomous D=Differential)

BWR - Bearing and distance to waypoint - rhumb line

\$**BWR,hhmmss.ss,llll.ll,a,yyyyy.yy,a,x.x,T,x.x,M,x.x,N,c--c,a,*hh<CR><LF>
 1 2 3 4 5 6 7 8 9 10 11 12 13

1. UTC Time (unused)
2. Waypoint latitude (0.00000 to 9000.00000)
3. N/S
4. Waypoint longitude (0.00000 to 18000.00000)
5. E/W
6. Bearing, degrees true (unused)
7. Unit (unused)
8. Bearing, degrees magnetic (unused)
9. Unit (unused)
10. Distance, nautical miles (unused)
11. Unit (unused)
12. Waypoint ID (Max. 8 characters)
13. Mode Indicator (A=Autonomous D=Differential)

DBK - Depth below keel

\$**DBK,x.x,f,x.x,M,x.x,F,*hh<CR><LF>
 1 2 3 4 5 6

1. Water depth (0.00 to 99999.99)
2. feet
3. Water depth (0.00 to 99999.99)
4. Meters
5. Water depth (0.00 to 99999.99)
6. Fathom

DBS - Depth below surface

\$**DBS,x.x,f,x.x,M,x.x,F,*hh<CR><LF>
 1 2 3 4 5 6

1. Water depth (0.00 to 99999.99)
2. feet
3. Water depth (0.00 to 99999.99)
4. Meters
5. Water depth (0.00 to 99999.99)
6. Fathom

DBT - Depth below transducer

\$**DBT,x.x,f,x.x,M,x.x,F,*hh<CR><LF>
 1 2 3 4 5 6

1. Water depth (0.00 to 99999.99)
2. feet
3. Water depth (0.00 to 99999.99)
4. Meters
5. Water depth (0.00 to 99999.99)
6. Fathoms

DPT - Depth

\$**DPT,x.x,x.x,x.x,*hh<CR><LF>
 1 2 3

1. Water depth relative to the transducer, meters (0.00 to 99999.99)
2. Offset from transducer, meters (-99.99 to 99.99, null)
3. Maximum range scale in use (unused)

GGA - Global positioning system (GPS) fix data

```
$**GGA,hhmmss.ss,llll.ll,a,yyyyy.yy,a,x,xx,x.x,x.x,M,x.x,M,x.x,xxxx,*hh<CR><LF>
```

1 2 3 4 5 6 7 8 9 10 11 12 13 14

1. UTC Time (unused)
2. Latitude (0.00000 to 9000.00000)
3. N/S
4. Longitude (0.00000 to 18000.00000)
5. E/W
6. GPS quality indicator (1 to 5)
7. Number of satellite in use (unused)
8. Horizontal dilution of precision (unused)
9. Antenna altitude above/below mean sea level (unused)
10. Unit, m (unused)
11. Geoidal separation (unused)
12. Unit, m (unused)
13. Age of differential GPS data (unused)
14. Differential reference station ID (unused)

GLL - Geographic position

```
$**GLL,llll.lll,a,yyyyy.yyy,a,hhmmss.ss,a,x,*hh<CR><LF>
```

1 2 3 4 5 6 7

1. Latitude (0.00000 to 9000.00000)
2. N/S
3. Longitude (0.00000 to 18000.00000)
4. E/W
5. UTC of position (unused)
6. Status (A=data valid)
7. Mode indicator (A=Autonomous D=Differential)

GNS - GNSS fix data

```
$**GNS,hhmmss.ss,llll.ll,a,yyyyy.yy,a,c--c,xx,x.x,x.x,x.x,x.x,x.x,a*hh<CR><LF>
```

1 2 3 4 5 6 7 8 9 10 11 12 13

1. UTC of position (unused)
2. Latitude (0.00000 to 9000.00000)
3. N/S
4. Longitude (0.00000 to 18000.00000)
5. E/W
6. Mode indicator
A=Autonomous, D=Differential, P=Precise, R=Real Time Kinematic, F=Float RTK
7. Total number of satellites in use (unused)
8. HDOP (unused)
9. Antenna altitude, meters (unused)
10. Geoidal separation (unused)
11. Age of differential data (unused)
12. Differential reference station ID (unused)
13. Navigational status indicator (S=Safe)

HDG - Heading, deviation and variation

```
$**HDG,x.x,x.x,a,x.x,a*hh<CR><LF>
```

1 2 3 4 5

1. Magnetic sensor heading, degrees (0.00 to 360.00)
2. Magnetic deviation, degrees (0.0 to 180.00)
3. E/W
4. Magnetic variation, degrees (0.0 to 180.00)
5. E/W

HDM - Heading magnetic

\$**HDM,x.x,M*hh<CR><LF>
1 2

1. Heading, degrees (0.00 to 360.00)
2. Magnetic (M)

HDT - Heading true

\$**HDT,xxx.x,T*hh<CR><LF>
1 2

1. Heading, degrees (0.00 to 360.00)
2. True (T)

HTC - Heading/Track control command

\$**HTC,A,x.x,a,a,a,x.x,x.x,x.x,x.x,x.x,x.x,x.x,a,a*hh<CR><LF>
1 2 3 4 5 6 7 8 9 10 11 12 13 14

1. Override (A = in use, V = not in use)
2. Commanded rudder angle, degrees (-180.00 to 180.00)
3. Commanded rudder direction, (L/R=Port/starboard, null)
4. Selected steering mode
(M = Manual steering S = Standalone (heading control) H = Heading control T = Track control R = Rudder control)
5. Turn mode (R=Radius controlled, T=Turn rate controlled, N=Turn is not controlled)
6. Commanded rudder limit, degrees (unsigned number) (unused)
7. Commanded off-heading limit, degrees (unsigned number) (unused)
8. Commanded radius of turn for heading changes, n.miles (unused)
9. Commanded rate of turn to heading changes, deg/min (unused)
10. Commanded heading-to-steer, degrees (unused)
11. Commanded off-track limit, n.miles (unsigned number) (unused)
12. Commanded track, degrees (unused)
13. Heading reference in use, T/M (unused)
14. Sentence status (unused)

HTD - Heading/Track Control Data

\$**HTD,A,x.x,a,a,a,x.x,x.x,x.x,x.x,x.x,x.x,x.x,a,A,A,x.x*hh<CR><LF>
1 2 3 4 5 6 7 8 9 10 11 12 13 14 15 16 17

1. Override (A=In use, V=Not in use)
2. Commanded rudder angle, degrees (-180.00 to 180.00)
3. Commanded rudder direction (L/R=Port/starboard, null)
4. Selected steering mode
(M = Manual steering, S = Standalone (heading control), H = Heading control, T = Track control, R = Rudder control)
5. Turn mode (R=Radius controlled, T=Turn rate controlled, N=Turn is not controlled)
6. Commanded rudder limit, degrees (unsigned number) (unused)
7. Commanded off-heading limit, degrees (unsigned number) (unused)
8. Commanded radius of turn for heading changes, n.miles (unused)
9. Commanded rate of turn to heading changes, deg/min (unused)
10. Commanded heading-to-steer, degrees (unused)
11. Commanded off-track limit, n.miles (unsigned number) (unused)
12. Commanded track, degrees (unused)
13. Heading reference in use, T/M (unused)
14. Rudder status (A=Within limits, V=Limit reached or exceeded) (unused)
15. Off-heading status (A=Within limits, V=Limit reached or exceeded) (unused)
16. Off-track status (A=Within limits, V=Limit reached or exceeded) (unused)
17. Vessel heading, degrees (unused)

MTW - Water temperature

\$**MTW,x.x,C<CR><LF>
 1

1. Water temperature, degrees C (-9.999 to 99.999)

MWD - Wind direction and speed

\$--MWD,x.x,T,x.x,M,x.x,N,x.x,M*hh<CR><LF>
 1 2 3 4

1. Wind direction, degrees True (0.00 to 360.00)
2. Wind direction, degrees Magnetic (unused)
3. Wind speed, knots (0.00 to 9999.99)
4. Wind speed, meters/second (0.00 to 9999.99)

MWV - Wind speed and angle

\$**MWV,x.x,a,x.x,a,A*hh<CR><LF>
 1 2 3 4 5

1. Wind angle, degrees (0.00 to 360.00)
2. Reference (R/T)
3. Wind speed (0.00 to 9999.99)
4. Wind speed units (K=km/h, M=m/s, N=nm, S=statute miles/h)
5. Status (A=Valid)

RMB - Recommended minimum specific navigation information

\$**RMB,A,x.x,a,c--c,c--c,llll.ll,a,yyyyy.yy,a,x.x,x,x,x.x,A,a*hh <CR><LF>
 1 2 3 4 5 6 7 8 9 10 11 12 13 14

1. Data status (A=Data valid)
2. Cross track error (NM) (unused)
3. Direction to steer (L/R) (unused)
4. Origin waypoint ID (unused)
5. Destination waypoint ID (max. 8 characters)
6. Destination waypoint latitude (0.00000 to 9000.00000)
7. N/S
8. Destination waypoint longitude (0.00000 to 18000.00000)
9. E/W
10. Range to destination, nautical miles (unused)
11. Bearing to destination, degrees true (unused)
12. Destination closing velocity, knots (unused)
13. Arrival status (unused)
14. Mode indicator (A=Autonomous mode, D=Differential mode)

RMC - Recommended minimum specific GPS data

\$**RMC,hhmmss.ss,A,llll.ll,a,yyyyy.yy,a,x.x,x.x,ddmmyy,x.x,a,a*hh<CR><LF>
 1 2 3 4 5 6 7 8 9 10 11 12 13

1. UTC of position fix (unused)
2. Status (A=data valid)
3. Latitude (0.00000 to 9000.00000)
4. N/S
5. Longitude (0.00000 to 18000.00000)
6. E/W
7. Speed over ground, knots (0.00 to 9999.99)
8. Course over ground, degrees true (0.00 to 360.00)
9. Date (unused)
10. Magnetic variation, degrees E/W (unused)
11. E/W (unused)
12. Mode indicator
(A=Autonomous mode, D=Differential mode, F=Float RTK, P=Precise, R=Real time kinematic)
13. Navigational status indication (S=Safe)

ROT - Rate of turn

\$**ROT,x.x,A*hh<CR><LF>
1 2

1. Rate of turn, deg/min, "-"=bow turns to port (-9999.99 to 9999.99)
2. Status (A=data valid)

RPM - Revolutions

\$**RPM, a, x, x.x, x.x, A*hh<CR><LF>
1 2 3 4 5

1. Source (S=shaft E=engine)
2. Engine or shaft number
(numbered from centerline, 0 = single or on centerline, odd = starboard, even = port) (0 to 9)
3. Speed, revolutions/min (-1000.0 to 1000.0)
4. Propeller pitch (-100.0 to 100.0)
5. Status (A=data invalid)

RSA - Rudder sensor angle

\$**RSA,x.x,A,x.x,A*hhCR><LF>
1 2 3 4

1. Starboard (or single) rudder sensor data (-180 - 180.0)
2. Starboard (or single) rudder sensor status (A=Vaild)
3. Port rudder sensor data (-180.00 to 180.00)
4. Port rudder sensor status (A=Vaild)

THS - Rudder sensor angle

\$**THS,x.x,a*hh<CR><LF>
1 2

1. Heading, degrees True (0.00 to 360.00)
2. Mode indicator (A=Autonomous)

VBW - Dual ground/water speed

\$**VBW,x.x,x.x,A,x.x,x.x,A,x.x,A,x.x,A,*hh<CR><LF>
1 2 3 4 5 6 7 8 9 10

1. Longitudinal water speed, knots (-9999.999 to 9999.999)
2. Transverse water speed, knots (-9999.999 to 9999.999)
3. Status: water speed (A=Data valid)
4. Longitudinal ground speed, knots (-9999.999 to 9999.999)
5. Transverse ground speed, knots (-9999.999 to 9999.999)
6. Status: ground speed (A=Data valid)
7. Stern transverse water speed, knots (-9999.999 to 9999.999)
8. Status: stern water speed (A=Data valid)
9. Stern transverse ground speed, knots (-9999.999 to 9999.999)
10. Status: stern ground speed (A=Data valid)

VHW - Water speed and heading

\$**VHW,x.x,T,x.x,M,x.x,N,x.x,K,*hh <CR><LF>
1 2 3 4 5 6 7 8

1. Heading, degree True (0.00 to 360.00)
2. T=True (fixed)
3. Heading, degree Magnetic (0.00 to 360.00)
4. M=Magnetic (fixed)
5. Speed, knots (0.00 to 9999.99)
6. N=Knots (fixed)
7. Speed, km/h (0.00 to 9999.99)
8. K=km/h (fixed)

VLW - Dual ground/water distance

\$**VLW,x.x,N,x.x,N,x.x,N,x.x,N,*hh<CR><LF>
1 2 3 4 5 6 7 8

1. Total cumulative water distance (0.00 to 999999.99)
2. N=Nautical miles
3. Water distance since reset (0.00 to 999999.99)
4. N=Nautical miles
5. Total cumulative ground distance (unused)
6. N=Nautical miles (unused)
7. Ground distance since reset (unused)
8. N=Nautical miles (unused)

VTG - Course over ground and ground speed

\$**VTG,x.x,T,x.x,M,x.x,N,x.x,K,a,*hh <CR><LF>
1 2 3 4 5 6 7 8 9

1. Course over ground, degrees True (0.00 to 360.00)
2. T=True (fixed)
3. Course over ground, degrees Magnetic (0.00 to 360.00)
4. M=Magnetic (fixed)
5. Speed over ground, knots (0.00 to 9999.99)
6. N=Knots (fixed)
7. Speed over ground, km/h (0.00 to 9999.99)
8. K=km/h (fixed)
9. Mode indicator (A=Autonomous, D=Differential, P=Precise)

VWR - Relative (Apparent) wind speed and angle

\$**VWR,x.x,a,x.x,N,x.x,M,x.x,K<CR><LF>
1 2 3 4 5 6 7 8

1. Measured wind angle relative to the vessel, degrees (0.00 to 180.00)
2. L=Left semicircle, R=Right semicircle
3. Velocity, knots (0.00 to 9999.99)
4. Unit (N, fixed)
5. Velocity, m/s (0.00 to 9999.99)
6. Unit (M, fixed)
7. Velocity, km/h (0.00 to 9999.99)
8. Unit (K, fixed)

VWT - True wind speed and angle

\$**VWT,x.x,a,x.x,N,x.x,M,x.x,K<CR><LF>
1 2 3 4 5 6 7 8

1. Measured wind angle relative to the vessel, degrees (0.00 to 180.00)
2. L=Left semicircle, R=Right semicircle
3. Velocity, knots (0.00 to 9999.99)
4. Unit (N, fixed)
5. Velocity m/s (0.00 to 9999.99)
6. Unit (M, fixed)
7. Velocity, km/h (0.00 to 9999.99)
8. Unit (K, fixed)

WPL - Waypoint location

\$**WPL,IIII.II,a,yyyy.yy,a,c--c*hh<CR><LF>
1 2 3 4 5

1. Waypoint latitude (0.00000 to 9000.00000)
2. N/S
3. Waypoint longitude (0.00000 to 18000.00000)
4. E/W
5. Waypoint identifier (Max. 8 characters)

ZDA - Time and date

\$**ZDA,hhmmss.ss,xx,xx,xxxx,xx,xx<CR><LF>
 1 2 3 4 5 6

- 1. UTC
- 2. Day (UTC, 01 to 31)
- 3. Month (UTC, 01 to 12)
- 4. Year (UTC, 0000 to 9999)
- 5. Local zone, hours (00 to ±13)
- 6. Local zone, minutes (00 to 59)

Serial Interface

Baud rate is selectable from 4800 bps and 38400 bps. Complies with IEC 61162-2.

Input port (RD-A, RD-B)

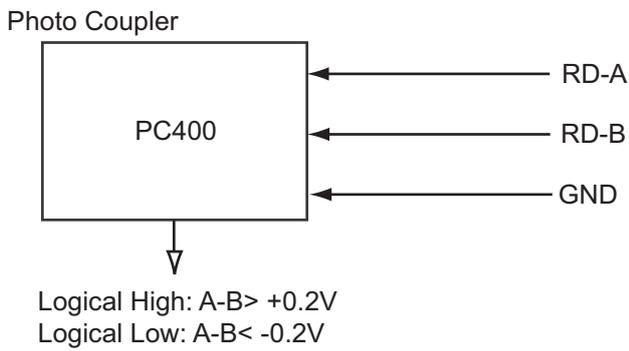

Output port (TD-A, TD-B)

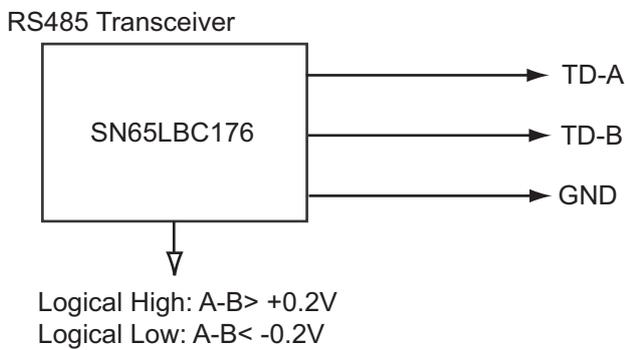

**SPECIFICATIONS OF REMOTE DISPLAY
RD-50**

1 REMOTE DISPLAY

- 1.1 Display type 8.4-inch color LCD, 640x480 dots
- 1.2 Picture color 256 colors
- 1.3 Data indication Ship's speed, Course, Heading, Trip, Depth, Rate of turn, Wind direction/speed, Rudder angle, Engine/ shaft RPM, Propeller pitch, Water temperature, Waypoint, Ship's position, Date/time
- 1.4 Remote control Remote controller (option) required
- 1.5 Remote dimmer Dimmer controller (option) required
- 1.6 Interface
 - Remote control Serial 1 port, 38,400 bps, 5 VDC output (for remote/dimmer controller)
 - Sensor NMEA0183 Ver1.5/2.0/3.0/4.0/4.1, Input: 1 port
 - Daisy chain (for RD-50) Output: 1 port, 38,400bps
- 1.7 Data sentences BWC, BWR, DBK, DBS, DBT, DPT, GLL, GNS, HDG, HDT, HDM, HTC, HTD, MTW, MWD, MWV, RMB, RMC, ROT, RPM, RSA, THS, VBW, VHW, VLW, VTG, VWR, VWT, WPL, ZDA

2 REMOTE CONTROLLER (OPTION)

- 2.1 Control button DISP, UNIT, MODE
- 2.2 Interface Serial, Input: 1 port, Output: 1 port, 38,400bps
5 VDC input (supplied from remote controller)
5 VDC output (for dimmer controller)

3 DIMMER CONTROLLER (OPTION)

- 3.1 Control button DAY/NT, BRILL (▲/▼)
- 3.2 Interface Serial, Output: 1 port, 38,400bps
5 VDC input (supplied from remote display or remote controller)

4 POWER SUPPLY

12-24 VDC: 1.0-0.5 A

5 ENVIRONMENTAL CONDITION

- 5.1 Ambient temperature
 - Remote display -25°C to +55°C
 - Remote/Dimmer controller -15°C to +55°C
- 5.2 Relative humidity 95% at 40°C
- 5.3 Degree of protection IP22, IP56 (optional waterproof box required)
- 5.4 Vibration IEC 60945

6 UNIT COLOR

N2.5

FURUNO

CODE NO.	001-081-900-00	26AC-X-9403-3
TYPE	CP26-01501	

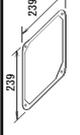
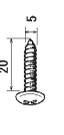
番号 NO.	名称 NAME	略図 OUTLINE	型名/規格 DESCRIPTIONS	数量 QTY	用途/備考 REMARKS
1	ケーブルクリップ (2) CABLE CLAMP (2)		26-003-1528-0 CODE NO. 100-355-110-10	1	
2	フラッシュマウント FLUSH MOUNTING SPONGE		26-003-1532-2 CODE NO. 100-355-202-10	1	
3	タップインドネジ TAPPING SCREW		5X20 SUS304 CODE NO. 000-171-997-10	4	

型式/コード番号が2原の場合、下段より上段に代わる選定部品であり、どちらが入っています。なお、品質は変わりません。
TWO TYPES AND CODES MAY BE LISTED FOR AN ITEM. THE LOWER PRODUCT MAY BE SHIPPED IN PLACE OF THE UPPER PRODUCT.
QUALITY IS THE SAME.
(略図の寸法は、参考値です。 DIMENSIONS IN DRAWING FOR REFERENCE ONLY.)

FURUNO ELECTRIC CO., LTD.

C4453-M03-D

FURUNO

CODE NO.	001-081-910-00	26AC-X-9501-1
TYPE	FP26-00601	

付属品表

ACCESSORIES					
番号 NO.	名称 NAME	略図 OUTLINE	型名/規格 DESCRIPTIONS	数量 QTY	用途/備考 REMARKS
1	液晶クリーニング LCD CLEANING CLOTH		02-156-1082-2 CODE NO. 100-332-852-10	1	
2	ネジキャップ CAP		26-003-1508-1 CODE NO. 100-356-091-10	4	

型式/コード番号が2原の場合、下段より上段に代わる選定部品であり、どちらが入っています。なお、品質は変わりません。
TWO TYPES AND CODES MAY BE LISTED FOR AN ITEM. THE LOWER PRODUCT MAY BE SHIPPED IN PLACE OF THE UPPER PRODUCT.
QUALITY IS THE SAME.
(略図の寸法は、参考値です。 DIMENSIONS IN DRAWING FOR REFERENCE ONLY.)

FURUNO ELECTRIC CO., LTD.

C4453-F01-B

CODE NO.	001-076-990-00	26AG-X-9401-1
TYPE	CP26-01101	1/1

工事材料表		REMOTE CONTROLLER		RD-501	
INSTALLATION MATERIALS		DIMENSION		REMARKS	
番号 NO.	名称 NAME	略図 OUTLINE	型名/規格 DESCRIPTIONS	数量 QTY	用途/備考 REMARKS
1	コネクタ CABLE TIE		CY-1506 CODE NO. 000-167-183-10	4	
2	圧着端子 CRIMP-ON LUG		FV2-4 CODE NO. 000-157-247-10	1	
3	圧着端子 CRIMP-ON LUG		FV5.5-4(LF) CODE NO. 000-166-744-10	2	
4	六角ナット 1/2 HEXAGONAL NUT		M3 SUS304 CODE NO. 000-167-477-10	4	
5	ミカキ丸平座金 FLAT WASHER		M3 SUS304 CODE NO. 000-167-453-10	4	
6	バネ座金 SPRING WASHER		M3 SUS304 CODE NO. 000-167-404-10	4	
7	バインドネジ BINDING HEAD SCREW		M3X12 SUS304 CODE NO. 000-171-998-10	4	

型式/コード番号が2段の場合、下段より上段に代わる通線部品であり、どちらが入っています。なお、品質は変わりません。
TWO TYPES AND CODES MAY BE LISTED FOR AN ITEM. THE LOWER PRODUCT MAY BE SHIPPED IN PLACE OF THE UPPER PRODUCT.
QUALITY IS THE SAME.
(略図の寸法は、参考値です。 DIMENSIONS IN DRAWING FOR REFERENCE ONLY.)

FURUNO ELECTRIC CO., LTD.

C4453-M01-B

CODE NO.	001-077-000-00	26AG-X-9402-1
TYPE	CP26-01201	1/1

工事材料表		DIMMER CONTROLLER		RD-502	
INSTALLATION MATERIALS		DIMENSION		REMARKS	
番号 NO.	名称 NAME	略図 OUTLINE	型名/規格 DESCRIPTIONS	数量 QTY	用途/備考 REMARKS
1	コネクタ CABLE TIE		CY-1506 CODE NO. 000-167-183-10	2	
2	圧着端子 CRIMP-ON LUG		FV2-4 CODE NO. 000-157-247-10	1	
3	圧着端子 CRIMP-ON LUG		FV5.5-4(LF) CODE NO. 000-166-744-10	1	
4	六角ナット 1/2 HEXAGONAL NUT		M3 SUS304 CODE NO. 000-167-477-10	4	
5	ミカキ丸平座金 FLAT WASHER		M3 SUS304 CODE NO. 000-167-453-10	4	
6	バネ座金 SPRING WASHER		M3 SUS304 CODE NO. 000-167-404-10	4	
7	バインドネジ BINDING HEAD SCREW		M3X12 SUS304 CODE NO. 000-171-998-10	4	

型式/コード番号が2段の場合、下段より上段に代わる通線部品であり、どちらが入っています。なお、品質は変わりません。
TWO TYPES AND CODES MAY BE LISTED FOR AN ITEM. THE LOWER PRODUCT MAY BE SHIPPED IN PLACE OF THE UPPER PRODUCT.
QUALITY IS THE SAME.
(略図の寸法は、参考値です。 DIMENSIONS IN DRAWING FOR REFERENCE ONLY.)

FURUNO ELECTRIC CO., LTD.

C4453-M02-B

表1 TABLE 1

寸法区分 (mm) DIMENSION	公差 (mm) TOLERANCE
L ≤ 50	±1.5
50 < L ≤ 100	±2.5
100 < L ≤ 500	±3

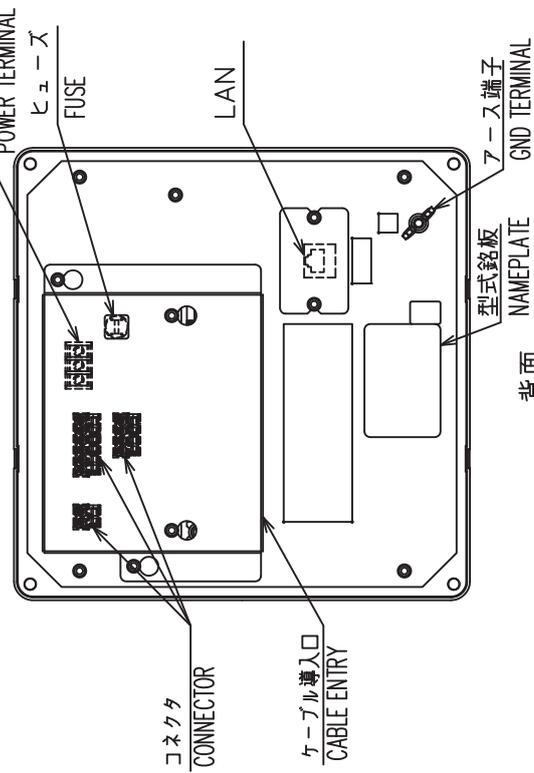
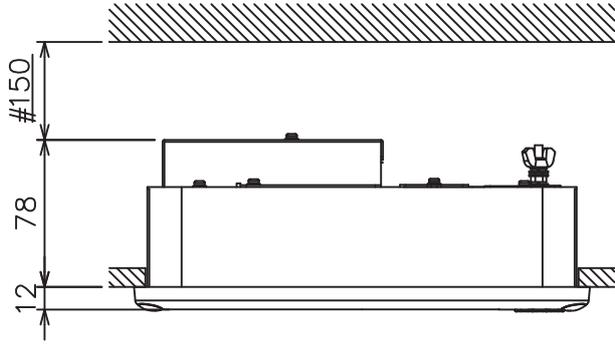
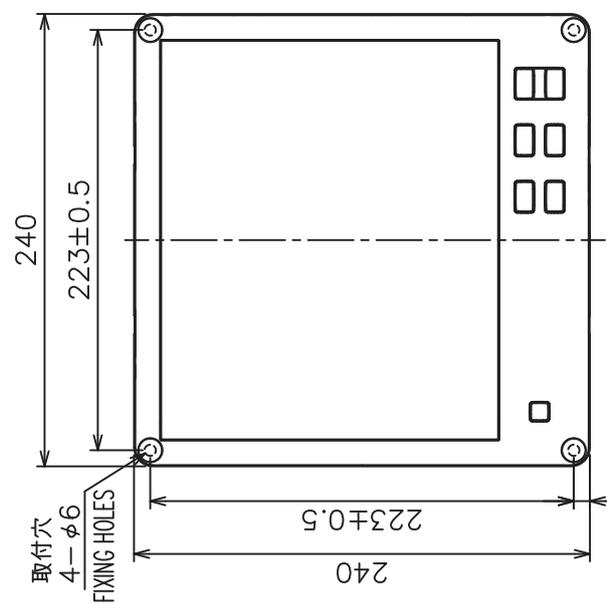
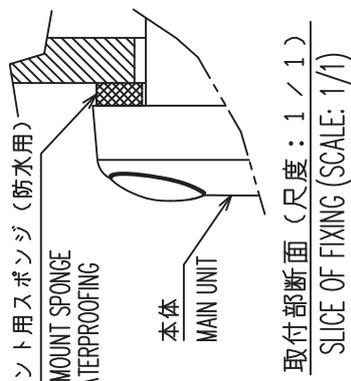
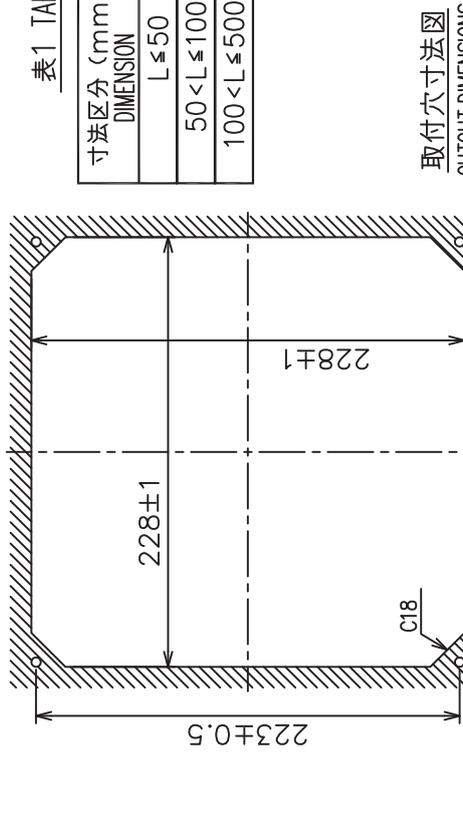

DRAWN	17/Dec/2012	T. YAMASAKI	TITLE	RD-50
CHECKED	17/Dec/2012	H. MAKI	名称	リモートディスプレイ (埋込装備)
APPROVED	18/Dec/2012	Y. NISHIYAMA	外寸図	
SCALE	1/4	1/4	NAME	REMOTE DISPLAY (FLUSH MOUNT)
DWG.No.	C4453-G02-C	REF.No.	26-003-102G-4	OUTLINE DRAWING

- 注記
- 1) 指定外の寸法公差は表1による。
 - 2) #印寸法は最小サービスマン間寸法とする。
 - 3) 取付用ネジはバイネジ呼び径5×20を使用のこと。
- NOTE
1. TABLE 1 INDICATES TOLERANCE OF DIMENSIONS WHICH IS NOT SPECIFIED.
 2. #: MINIMUM SERVICE CLEARANCE.
 3. USE BIND TAPPING SCREWS $\phi 5 \times 20$ FOR FIXING THE UNIT.



表1 TABLE 1

寸法区分 (mm) DIMENSION	公差 (mm) TOLERANCE
L ≤ 50	±1.5
50 < L ≤ 100	±2.5
100 < L ≤ 500	±3

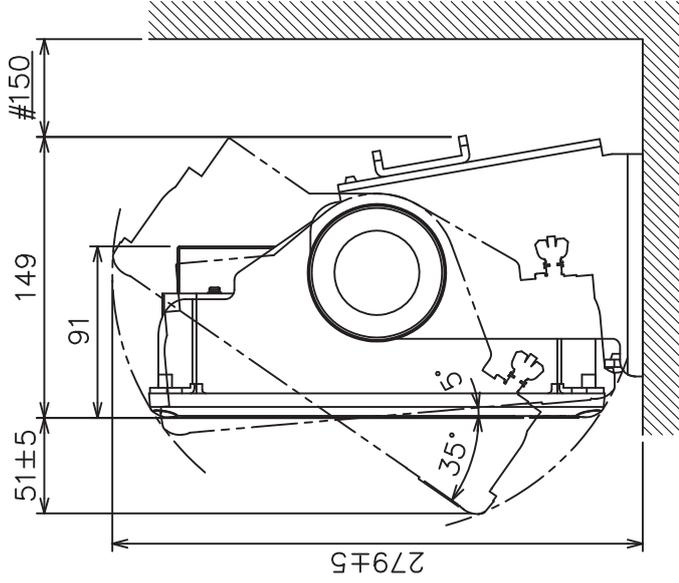
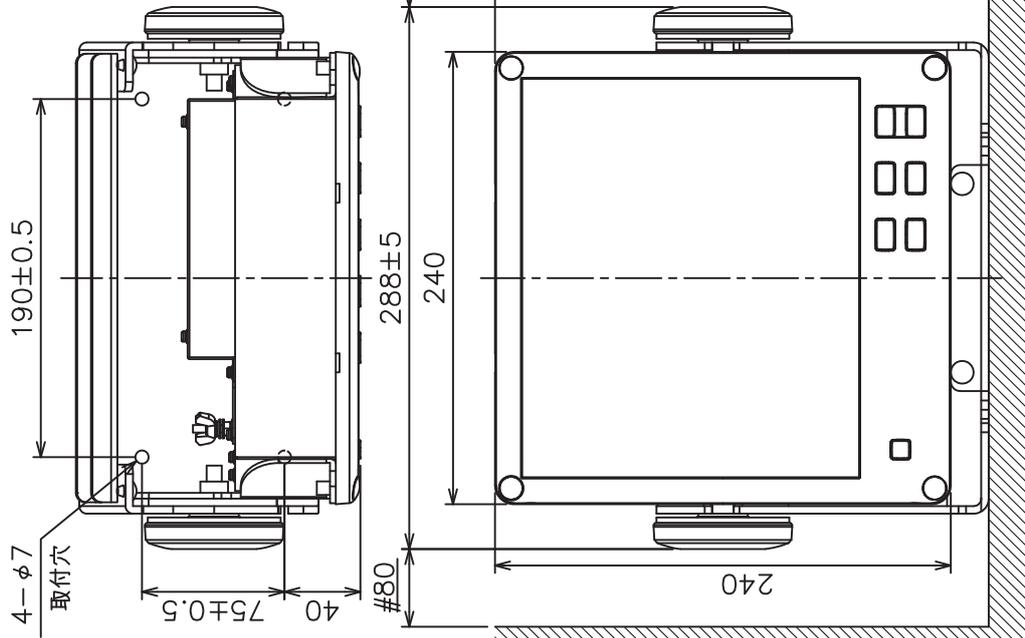
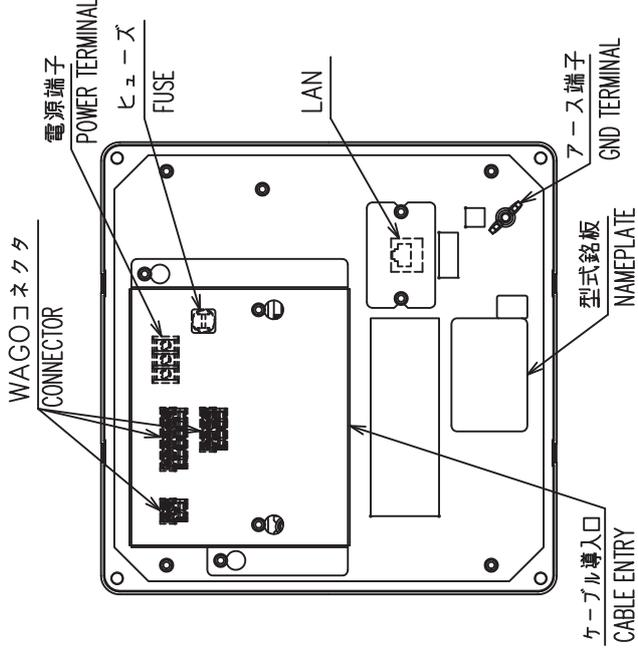

背面
REAR VIEW

- 注記 1) 指定外の寸法公差は表1による。
 2) #印寸法は最小サービスインスペーシングとする。
 3) 取付用ネジはバイインドスタッド呼び径5×20を使用のこと。
- NOTE 1. TABLE 1 INDICATES TOLERANCE OF DIMENSIONS WHICH IS NOT SPECIFIED.
 2. #: MINIMUM SERVICE CLEARANCE.
 3. USE BIND TAPPING SCREWS φ5x20 FOR FIXING THE UNIT.

DRAWN	TITLE	REF.No.
1/Sep/09 I.YAMASAKI	RD-50	
CHECKED	名称	
1/Sep/09 I.TAKENO	リモートディスプレイ(卓上装備)	
APPROVED	外寸図	
15/Sep/09 R. Esumi	REMOTE DISPLAY (TABLETOP MOUNT)	
SCALE	NAME	
1/4	REMOTE DISPLAY (TABLETOP MOUNT)	
DWG.No.	REF.No.	
C4453-G01-A	26-003-101G-2	

表1 TABLE 1

寸法区分 (mm) DIMENSION	公差 (mm) TOLERANCE
$L \leq 50$	± 1.5
$50 < L \leq 100$	± 2.5
$100 < L \leq 500$	± 3

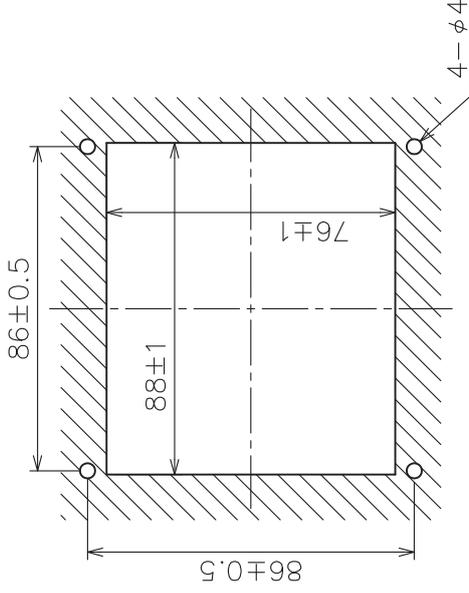
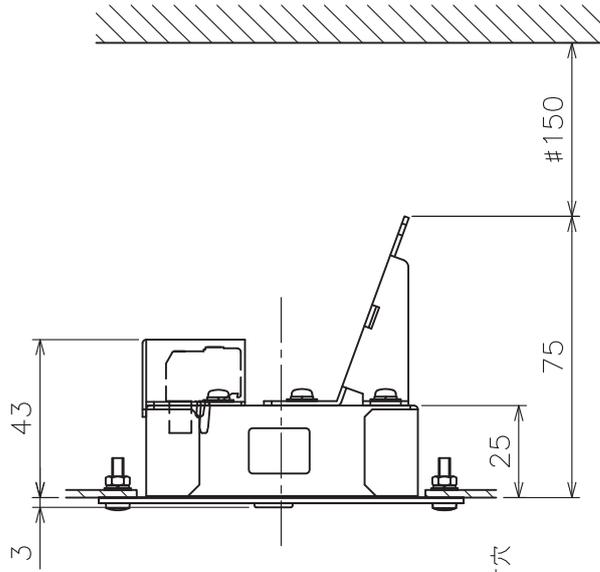
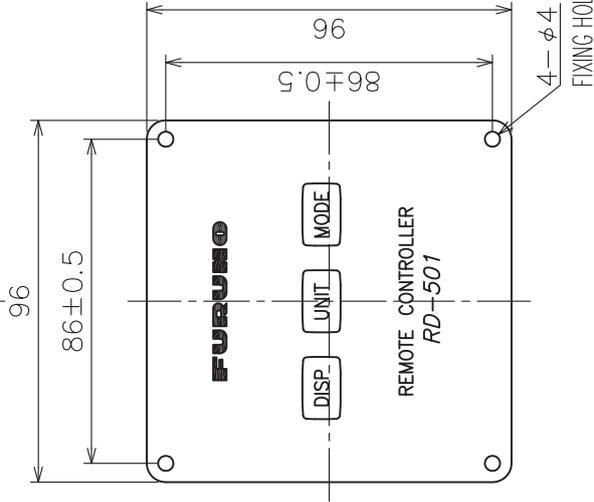
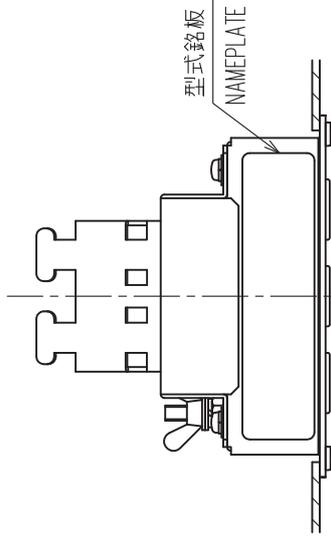

取付穴寸法図
CUTOUT DIMENSIONS
コネクタ
CONNECTOR

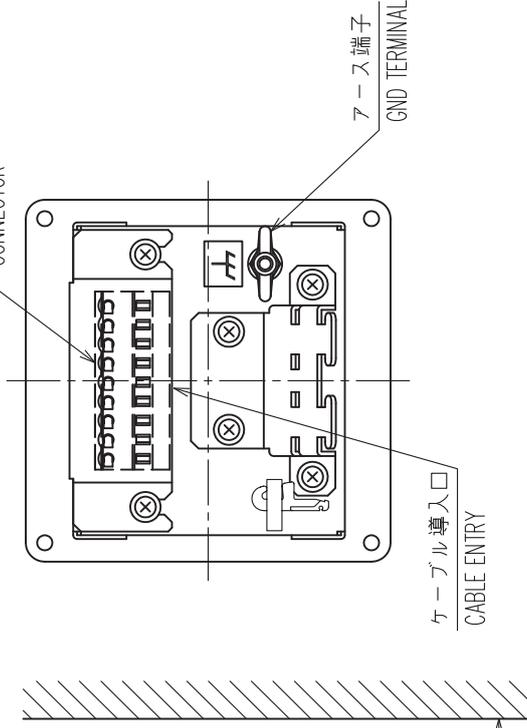

- 注記 1) 指定外の寸法公差は表1による。
 2) #印寸法は最小サービス空間寸法とする。
 3) 取付にはM3×12バインド小ネジ、M3平座金/バネ座金/ナットを使用のこと。
- NOTE 1. TABLE 1 INDICATES TOLERANCE OF DIMENSIONS WHICH IS NOT SPECIFIED.
 2. # MINIMUM SERVICE CLEARANCE.
 3. USE BINDING SCREWS M3x12 AND M3 P.W./S.W./ NUTS FOR FIXING THE UNIT.

DRAWN	25/May/09 I.YAMASAKI	TITLE	RD-501
CHECKED	26/May/09 I.TAKENO	名称	リモート操作部 (埋込装備)
APPROVED	9/Jun/09 R.Esumi	外寸図	
SCALE	1/2	質量	0.38 kg
DWG.No.	C4453-603-B	REF.No.	26-003-200G-3

表1 TABLE 1

寸法区分 (mm) DIMENSION	公差 (mm) TOLERANCE
L ≤ 50	±1.5
50 < L ≤ 100	±2.5
100 < L ≤ 500	±3

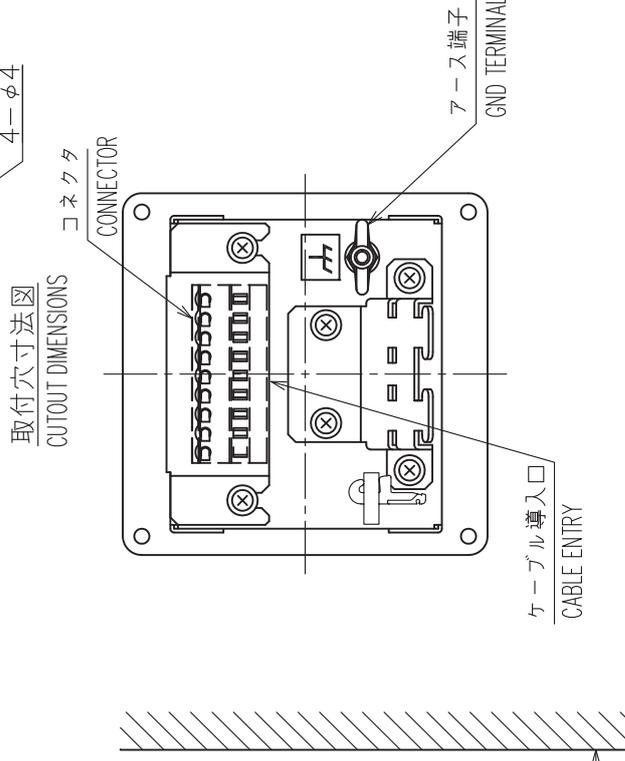
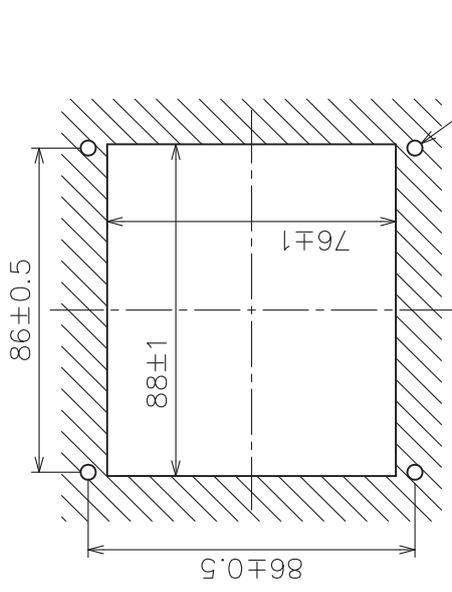
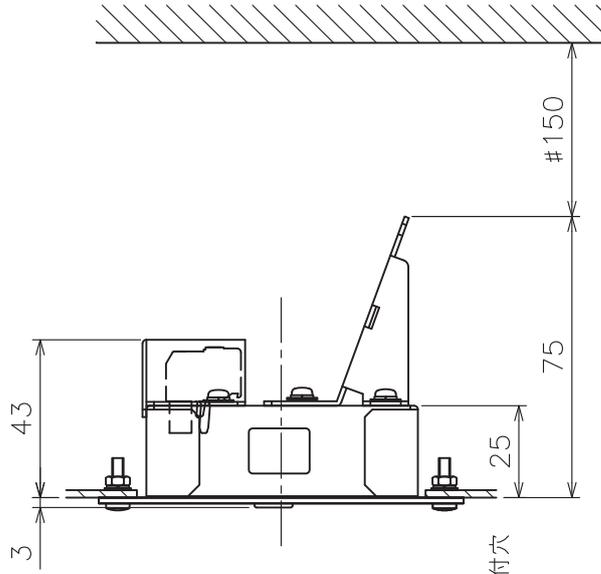
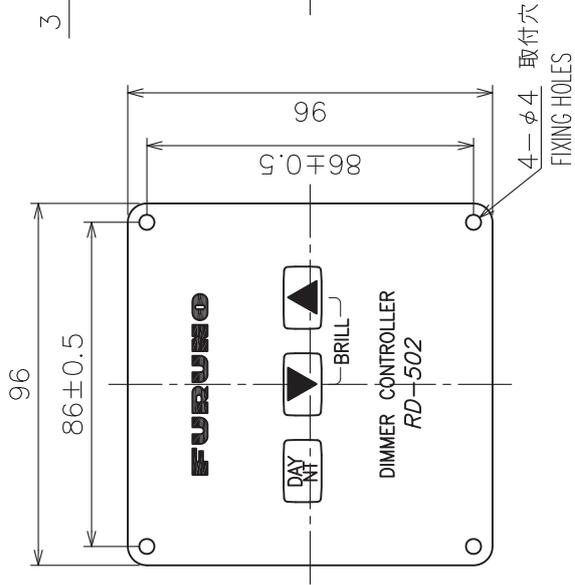
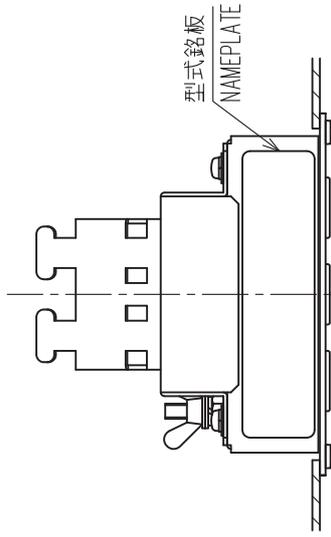

- 注記 1) 指定外の寸法公差は表1による。
 2) #印寸法は最小サービスペース寸法とする。
 3) 取付はM3×1.2バインド小ネジ、M3平座金/バネ座金/ナットを使用のこと。
- NOTE 1. TABLE 1 INDICATES TOLERANCE OF DIMENSIONS WHICH IS NOT SPECIFIED.
 2. # MINIMUM SERVICE CLEARANCE.
 3. USE BINDING SCREWS M3x1.2 AND M3 P.W./S.W./ NUTS FOR FIXING THE UNIT.

DRAWN	26/May/09 I.YAMASAKI	TITLE	RD-502
CHECKED	26/May/09 I.TAKENO	名称	調光器 (埋込装備)
APPROVED	9/Jun/09 R.Esumi	外寸図	
SCALE	1/2	質量	0.38 kg
DWG.No.	C4453-G04-C	REF.No.	26-003-250G-4

1) NMEAデータを共有する場合 TO USE NMEA DATA JOINTLY

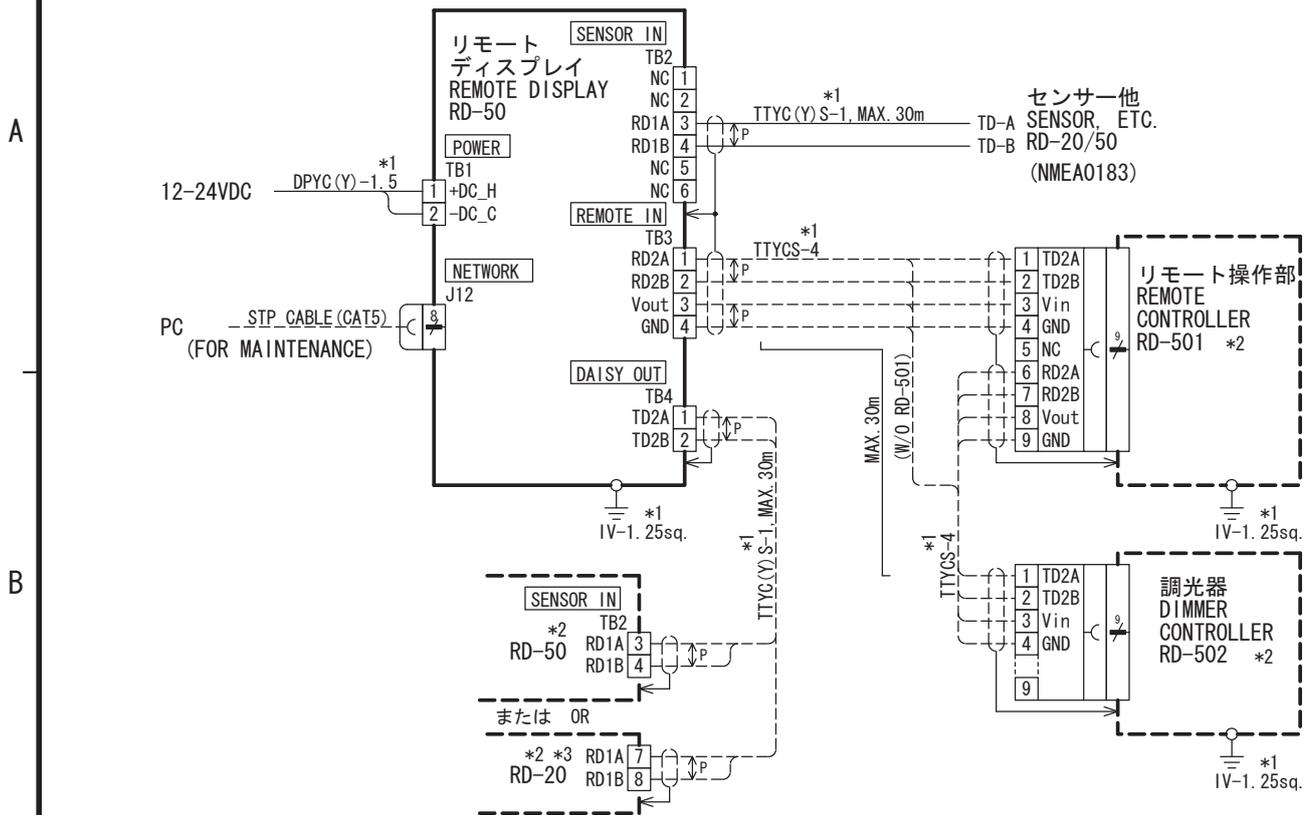

2) 調光制御のみを共有する場合 TO USE DIMMER CONTROL ONLY JOINTLY

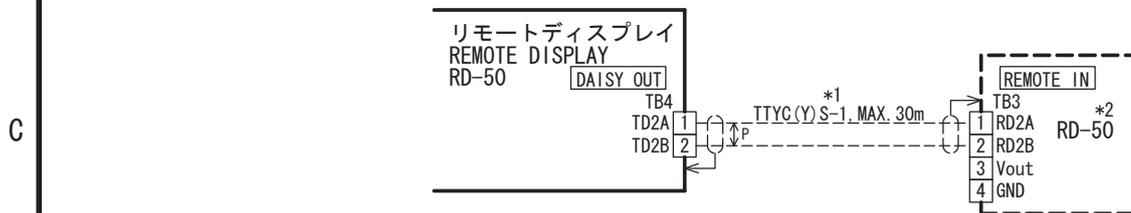

注記

- * 1) 造船所手配。
- * 2) オプション。
- * 3) RD-50の調光器はRD-20を制御できません。

NOTE

- *1: SHIPYARD SUPPLY.
- *2: OPTION.
- *3: THE DIMMER CONNECTED TO RD-50 DOES NOT CONTROL RD-20.

DRAWN	10/Nov/2011 I. YAMASAKI	TITLE	RD-50
CHECKED	10/Nov/2011 H. MAKI	名称	リモートディスプレイ
APPROVED	11/Nov/2011 Y. NISHIYAMA		相互結線図
SCALE	MASS kg	NAME	REMOTE DISPLAY
DWG. No.	C4453-C01- B	REF. No.	26-003-0001-0
		INTERCONNECTION DIAGRAM	

INDEX

B

Brill menu2-22

C

Connection of power cable4-12

Controls..... 1-1

D

Daisy chain connection vii, 4-9

Data screen..... 1-6, 2-2

Depth graph2-10

Diagnostic test3-3

Digital indication2-18

Digital interfaceAP-5

Direction symbol2-20

Display brilliance 1-5

E

Engine/Shaft graphic.....2-17

F

Fabrication of cable.....4-11

Fuse replacement3-2

H

HDG/COG bearing2-7

I

Installation of RD-504-1

Installation of RD-501/RD-5024-4

L

LCD backlight life3-2

LCD test3-4

Left-right reversal screen2-21

List of termsAP-3

M

Maintenance3-1

Menu treeAP-1

P

Parts list3-8

Parts location3-7

Power on/off..... 1-3

Preset of scales/indications2-6

R

Rudder graphic2-14

S

Screen division..... 2-3, AP-2

Service menu4-13

Ship?s time 2-7, 2-25

Simulation mode3-6

Single connection..... vi, 4-8

Speed graphic.....2-8

Speed mode.....2-7

Speed select2-23

Summer time.....2-26

T

Time setup2-25

Trip distance2-27

U

Units of measurement.....2-18

User reset3-5

W

WAGO connector4-13

Water temperature graph2-12

Waterproof box DS-6054-5

Wind average2-22

Wind options2-8

Wiring4-8

EC Declaration of Conformity



We **FURUNO ELECTRIC CO., LTD.**

(Manufacturer)

9-52 Ashihara-Cho, Nishinomiya City, 662-8580, Hyogo, Japan

(Address)

declare under our sole responsibility that the product

REMOTE DISPLAY RD-50

(Model name, type number)

to which this declaration relates is in conformity with the following standard(s) or other normative document(s)

IEC 60945 Ed.4.0: 2002
IEC 60945 Ed.3.0: 1996, clauses 10.2 and 10.3

(title and/or number and date of issue of the standard(s) or other normative document(s))

For assessment, see

- Test Report FLI 12-09-068, November 27, 2009 prepared by Furuno Labotech International Co., Ltd.

This declaration is issued according to the Directive 2014/30/EU of the European Parliament and of the Council of 26 February 2014 on the harmonisation of the laws of the Member States relating to electromagnetic compatibility.

On behalf of Furuno Electric Co., Ltd.

Nishinomiya City, Japan
April 20, 2016

(Place and date of issue)

Yoshitaka Shogaki
Department General Manager
Quality Assurance Department

(name and signature or equivalent marking of authorized person)